



Thank you for giving UL the opportunity to partner with you.

Please note, Follow-Up Procedure Revisions or Report Revisions do not include Authorization Pages, Indices, Section General, and/or Appendices unless revisions were required or requested.

Should you have any questions, after reviewing the material, or need to report any inaccuracies, please reach out to your UL representative or find UL contact details for your local Customer Service Department at <https://www.ul.com/about/locations>.

Please find attached the related material

For your convenience, the below describes the related updates:

For revised/new documentation, please reference 2022-12-22 in the page headings.

E530382-VolX2-AuthorizationPage
E530382-volX2-Index
E530382-volX2-GII
E530382-20221222-CertificateofCompliance
E530382-A6002-DescriptionUL
Figure-26-Total
E530382-A6002-TestRecordUL

This material is provided on behalf of UL LLC (UL) or any authorized licensee of UL.

Times change, Trust Remains™

FOLLOW-UP SERVICE PROCEDURE
(TYPE R)AUDIO/VIDEO, INFORMATION AND COMMUNICATION TECHNOLOGY EQUIPMENT - COMPONENT
(AZOT2, AZOT8)

Manufacturer:	SEE ADDENDUM FOR MANUFACTURER LOCATIONS
Applicant:	535140 (Party Site) 2N TELEKOMUNIKACE a.s. Modranska 621/72 143 01 Praha 4 Prague 143 01 CZ
Recognized Company:	535140 (Party Site) SAME AS APPLICANT

Use of the Mark

This Follow-Up Service Procedure authorizes the above Manufacturer(s) to use the marking specified by UL LLC, or any authorized licensee of UL LLC, including the UL Contracting Party, only on products when constructed, tested and found to be in compliance with the requirements of this Follow-Up Service Procedure and in accordance with the terms of the applicable service agreement with UL Contracting Party. The UL Contracting Party for Follow-Up Services is listed in the addendum to this Follow-Up Service Procedure ("UL Contracting Party"). UL Contracting Party and UL LLC are referred to jointly herein as "UL."

It is the responsibility of the Applicant, Manufacturer(s), and Recognized Company to make sure that only the products meeting the aforementioned requirements bear the authorized Marks of UL LLC, or any authorized licensee of UL LLC.

Additional Responsibilities

Additional responsibilities, duties and requirements for the Applicant and Manufacturers are defined under Additional Resources at the following website: <https://www.ul.com/fus>. Manufacturers without Internet access may obtain the current version of these documents from their local UL customer service representative or UL field representative. For assistance, or to obtain a paper copy of these documents or the Follow-Up Service Terms referenced below, please contact UL's Customer Service at <https://www.ul.com/aboutul/locations/>, select a location and enter your request, or call the number listed for that location.

Acceptance of Follow-Up Services

The Applicant and the specified Manufacturer(s) and any Recognized Company in this Follow-Up Service Procedure must agree to receive Follow-Up Services from UL Contracting Party. If your applicable service agreement is a Global Services Agreement ("GSA"), the Applicant, the specified Manufacturer(s), and any Recognized Company will be bound to a Service Agreement for Follow-Up Services upon the earliest by any Subscriber of a) use of the prescribed UL Mark, b) acceptance of the factory inspection, or c) payment of the Follow-Up Service fees. The Service Agreement incorporates such GSA, this Follow-Up Service Procedure and the Follow-Up Service Terms which can be accessed by clicking the following link: <https://www.ul.com/resources/contracts/follow-up-service-terms>. In all other events, Follow-Up Services will be governed by and incorporate the terms of your applicable service agreement and this Follow-Up Service Procedure.

Use and Ownership of the Follow-Up Service Procedure

This Follow-Up Service Procedure, and any subsequent revisions, is the property of UL and is not transferable. This Follow-Up Service Procedure contains confidential information for use only by the Applicant, the specified Manufacturer(s), and representatives of UL and is not to be used for any other purpose. It is provided to the Subscribers with the understanding

that it is not to be copied, either wholly or in part unless specifically allowed, and that it will be returned to UL, upon request.

Definition of Terms

Capitalized terms used but not defined herein have the meanings set forth in the GSA and the applicable Service Terms or any other applicable UL service agreement.

No Third Party Liability

UL shall not incur any obligation or liability for any loss, expense or damages, including incidental, consequential or punitive damages arising out of or in connection with the use or reliance upon this Follow-Up Service Procedure to anyone other than the above Manufacturer(s) as provided in the agreement between UL LLC or an authorized licensee of UL LLC, including UL Contracting Party, and the Manufacturer(s).

Certification Body

UL LLC has signed below solely in its capacity as the certification body to indicate that this Follow-Up Service Procedure fulfills the requirements for certification documentation issued by the certification body. The certification body's accreditation status for the applicable certification scheme and identification of the accreditation body can be found at <https://www.ul.com/resources/accreditation>.

Deborah Jennings-Conner
VP Regulatory Services
UL LLC

LOCATION

(100512-968) 34667 (Party Site)
Nvision Czech Republic A.S
Odstepny Zavod Votice
KLASTERNI 1
Votice 25101 CZ
Factory ID: NONE
UL Contracting Party for above site is: UL GmbH

File		Volume	Page	Date:
E530382	Index	X2	1	22-Dec-22

Index

<u>Product Type</u>	<u>Model/Type Reference</u>	<u>Report Reference #</u>	<u>Status</u>
Lift communication system	2N LiftIP 2.0 2N Voice Alarm Station Switch 2N LiftIP 2.0 relay extender 2N Voice Alarm Station Audio Unit	E530382-A6002-UL	

Generic Inspection Instructions

GENERIC INSPECTION INSTRUCTIONS

Product Category	Listing / Classification CCN	Component Recognition CCN **
Audio Video, Information and Communication Technology Equipment	AZOT, AZOT7	AZOT2, AZOT8
Power Supplies for Audio Video, Information and Communication Technology Equipment	QQJQ, QQJQ7	QQJQ2, QQJQ8
Information Technology Equipment Including Electrical Business Equipment	NWGQ, NWGQ7	NWGQ2, NWGQ8
Power Supplies for Information Technology Equipment Including Electrical Business Equipment	QQGQ, QQGQ7	QQGQ2, QQGQ8

** These instructions shall also be used for the indicated Component Recognition CCNs unless specifically exempted from the factory production-line tests as noted in each individual Test Report.

These instructions contain the UL LLC Follow-Up inspection requirements for manufacturing and production-line tests. These requirements are considered to be certification requirements related to Follow-Up inspection of equipment, as such, they are not included in the Bi-National Standard as deviations from IEC 60950 or IEC 60950-1.

These instructions consist of the following Parts:

Part	Description
AA	Instructions and Duties for UL Representative
AB	Instructions for Follow-Up Tests at UL
AC	Responsibilities and Requirements for Manufacturer
AD	General Terminology
AE	General Product Construction Requirements
AF	UL Certification Marks

Generic Inspection Instructions

PART AA

INSTRUCTIONS AND DUTIES FOR UL REPRESENTATIVE

AA1.0	UL REPRESENTATIVE'S DUTIES
AA1.1	<p>The UL Representative's duties include, but are not limited to:</p> <ul style="list-style-type: none"> A. Examining the construction of production intended to bear the UL Mark or Marking to determine compliance with the description of the product and any other requirements expressed in this Procedure. B. Where so specified in each Test Report, forwarding samples to UL for Follow-Up tests C. Where so specified by Part AC, inspecting the test records and facilities of the manufacturer to ensure that: <ul style="list-style-type: none"> 1. The proper number of samples are undergoing the required tests, and 2. The required tests are being performed correctly, and 3. The proper information is being recorded and is up-to-date, and 4. The instruments being used for the tests have been calibrated at the prescribed interval and are in good working order.
AA2.0	PROCEDURE IN CASE OF NONCONFORMANCE
AA2.1	<p>Report to the manufacturer and UL LLC by means of a Variation Notice (VN) if:</p> <ul style="list-style-type: none"> A. Variations in construction are found, or B. The manufacturer's method and/or frequency of testing is not as described, or C. The test records maintained by the manufacturer are not as described, or D. The manufacturer's inspection program is not being performed as described, or E. Nonconforming test results are witnessed during tests conducted specifically for the UL Representative.
AA2.2	<p>Explain to the manufacturer that a VN is a means of communication with the manufacturer and applicant and forms a record of those items where nonconformance to the Procedure has been found. Reference is to be made to "Information for Manufacturer's Variation Notices" on the back of the VN.</p>
AA2.3	<p>When a product does not conform with the Procedure, require that the manufacturer:</p> <ul style="list-style-type: none"> A. Remove any markings referencing UL from the product, or B. Suitably modify all products that do not comply with the Procedure, or C. Hold shipment pending further instructions from UL LLC <p>Exception: Production may be temporarily accepted if it can be determined that the nonconformance does not present a conflict with the applicable UL requirements, and laboratory testing (other than Follow-Up testing) is not required to determine product compliance.</p>

Generic Inspection Instructions

AA2.4	In the event of a disagreement between the manufacturer and the UL Representative as to whether a product is acceptable, the manufacturer shall hold production at the factory pending resolution of the variations. The manufacturer and applicant have the right to appeal the decision; and the UL Representative shall provide the name of the UL Engineer to whom the appeal is to be made. If the UL Engineer is not known the manufacturer is to be directed to contact the Client Advisor at the Reviewing Office. Should UL LLC grant temporary authorization for the continued use of the UL Mark, such temporary authorization shall only be for the time needed to review and/or process the Procedure revisions, or as otherwise specified to cover a particular lot or production run.
-------	--

AA3.0	INSTRUCTIONS FOR INSPECTION OF THE PRODUCT
AA3.1	At each inspection, samples of current production and/or stock shall be examined for compliance with the applicable descriptions and requirements contained in this Procedure.

AA4.0	INSTRUCTIONS FOR SAMPLE SELECTION
AA4.1	Certain products contained in this Procedure employ plastic enclosures that may require Follow-Up testing when the material is not a Recognized Component Plastic (QMFZ2). Where indicated in each Test Report, samples shall be selected once per year.
AA4.2	Where Follow-Up tests are required, the number and type of samples to be selected and the tests to be conducted are indicated in each Test Report. Where different models shown use identical enclosures (material and dimensions), a single enclosure can be sent to represent all models. When several alternate materials are specified for particular models, only a sample of the enclosure material currently in use should be sent.
AA4.3	The selected samples shall be appropriately tagged to indicate materials, manufacturer and model/cat. no., and shall be forwarded to the appropriate Reviewing Office. Each enclosure sample should also be marked with the Procedure and Report Reference Number that the sample represents.

Generic Inspection Instructions

PART AB

INSTRUCTIONS FOR FOLLOW-UP TESTS AT UL

AB1.0	GENERAL
AB1.1	A Test Report may require Follow-Up Tests for specific products. The stated sample requirements and test specifics are based the information in AB2.0.
AB1.1	The samples forwarded by the UL Representative shall be subjected to the specified tests in accordance with the method and basis of acceptability noted in AB3.0.
AB1.2	All clause references are from the Standard for Safety of Information Technology Equipment, UL 60950, Third Edition and UL 60950-1, First Edition.

AB2.0	SAMPLE REQUIREMENTS		
	Test	Samples	Test Specifics
AB2.1	Impact	1 complete unit or 1 enclosure with supporting framework	Ball drop height = 1.3 m
AB2.2	Drop	1 complete unit	Unit drop height = 0.75 m or 1 m
AB2.3	Stress Relief	1 complete unit; or 1 enclosure with supporting framework	Oven temperature (°C)
AB2.4	3/4-Inch (19 mm) Flammability	3 enclosures or 3 sample parts with representative wall thickness and ventilation openings.	Oven temperature (°C)
AB2.5	5-Inch (127 mm) Flammability	3 enclosures or 3 sample parts with representative wall thickness and ventilation openings.	Oven temperature (°C)
AB2.6	Needle-Flame	3 enclosures or 3 sample parts with representative wall thickness and ventilation openings.	Oven temperature (°C)

AB3.0	PERFORMANCE TESTS		
	Test	Method (sub-clause)	Basis for Acceptability
AB3.1	Impact	4.2.5	4.2.1
AB3.2	Drop	4.2.6	4.2.1
AB3.3	Stress Relief	4.2.7	4.2.1
AB3.4	3/4-Inch (19 mm) Flammability	Annex A, A.2	Annex A, A.2
AB3.5	5-Inch (127 mm) Flammability	Annex A, A.1	Annex A, A.1
AB3.6	Needle-Flame	Annex A, A.2.7	Annex A, A.2.7

Generic Inspection Instructions

PART AC

RESPONSIBILITIES AND REQUIREMENTS FOR MANUFACTURER

AC1.0	MANUFACTURER'S RESPONSIBILITIES (INCLUDING BUT NOT LIMITED TO)
AC1.1	Control of UL Mark - Restrict the use of markings that reference UL (either directly or by use of the name, an abbreviation of it, or the UL symbol or Classification Mark, or indirectly by means of agreed-upon markings that are understood to indicate acceptance by UL) to those products that are found by the manufacturer's own inspection to comply with the Procedure description. Such restrictions apply to packaging, brochures or other means of advertising that reference UL. Use of such markings is further limited by the agreements that have been executed by the subscriber and UL.
AC1.2	Substitution of Non-Specified Plastic Materials - The product description may require the use of a Recognized Plastic with a minimum flammability rating. For these cases, before a plastic material may be used, current UL certification documentation must be checked to ensure that the plastic material has an acceptable flammability rating as specified at the thickness of use. Acceptable UL certification documentation includes: (a) the current edition of the Recognized Component Directory or Supplement; (b) the UL Online Certification Directory (http://www.ul.com/database). NOTE: The above does not apply to materials for which the specific manufacturer and type designation of the plastic is specified in the individual Test Reports (i.e. Enclosures).
AC1.3	Substitution of Non-Specified PWB's - Before a printed wiring board may be used, current UL certification documentation must be checked to ensure that the maximum solder temperature and dwell time is as indicated and that the printed wiring board has minimum flammability and operating temperature ratings as specified in the individual Test Reports or other specified requirements. Acceptable UL certification documentation includes: (a) the current edition of the Recognized Component Directory or Supplement; (b) the UL Online Certification Directory (http://www.ul.com/database).
AC1.4	Production-Line Tests - Conduct the tests detailed in Part AC2.
AC1.5	Test Equipment Calibration – Determine that the test equipment is functioning properly and have it calibrated at least annually, or whenever it has been subject to abuse (such as being dropped or struck with an object) or its accuracy is questionable. Calibration may be by the manufacturer or an outside laboratory. In either case, it shall be by comparison with a Standard that is traceable to the applicable U.S. or the appropriate country's National Standard. Certification of calibration shall be maintained by the manufacturer until the next succeeding certification, and shall be readily available for review by the UL Representative. A letter from an outside laboratory or from an off-site manufacturer's calibration lab stating that their lab Standards are directly traceable to their country's National Standard and outlining their traceability path is considered adequate proof of traceability. A tag or marking on the equipment alone is not to be considered as equivalent to certification, but may be used to reference the certification report.
AC1.6	Packaging - Ensure that there are no markings on the carton, package or contents that are, or could be construed to be, in conflict with or an extension of the uses covered in the instruction manual or Procedure.

Generic Inspection Instructions

<p>AC1.7</p>	<p>Power Supply Cords –</p> <p>A. Non-Detachable Power Supply Cord - A non-detachable power supply cord must be provided if described in a Test Report.</p> <p>B. Detachable Power Supply Cord - A detachable power supply cord described in a Test Report may or may not be shipped with the unit(s). When a cord is provided, it should either:</p> <ol style="list-style-type: none"> 1. Comply with the specific description in the Procedure, or, 2. Be provided for products for use outside of the USA and/or Canada. In this case, the manufacturer is to supply the UL Representative with information that allows the Representative to verify that the products are intended to be sold outside of the USA and/or Canada <u>and</u> that the cord is certified or similarly appropriate for use in the destination country.
<p>AC1.8</p>	<p>User and Installation (Safety) Instructions provided with Bulk Shipped Equipment</p>
<p>AC1.8.1</p>	<p>Bulk shipments may be provided with installation instruction sets totaling less than the total number of products in the shipment provided, or none at all provided that the following conditions are met.</p> <p>A. Bulk Shipment to Distribution Center - Bulk shipments from a manufacturing facility covered by the Procedure describing the product to an off-site distribution center need not have the user/installation instructions provided with the shipment if appropriate safety instructions will be added to individual products at the distribution center before final redistribution to the consumer. It is the dual responsibility of the manufacturer and distribution center to have a system in place to insure that all instructions required by the Procedure are provided with the product before final distribution to the consumer, but this system will not be subject to review by UL Follow-Up Service.</p> <p>Example: A product shipped in a bulk lot to an overseas distribution center where appropriate installation instructions in the local language are added before final redistribution.</p> <p>B. Bulk Shipment to Single Destination Which Controls Installation of Equipment and Manages Distribution of Instructions - Bulk shipments from a manufacturing facility covered by the Procedure to a single destination, where the redistribution and installation of the product, including distribution of instructions, is under the control of the customer, may include just one set of use/installation instructions provided that the user/installation instructions (original or copies) are made available to the users of the equipment, as needed.</p> <p>Alternatively, user/installation instructions need not be provided with such a shipment if appropriate safety instructions will be sent separately to single destination that controls installation of the equipment. For such cases, it is the responsibility of the manufacturer to have a system in place to insure that all instructions required by the Procedure are provided to the consumer, but this system will not be subject to UL Follow-Up Service.</p> <p>Example: A product shipped in bulk lots to a corporate customer where the equipment will be redistributed and installed locally by the corporate customer, and copies of user/installation instructions are not needed for all users of the equipment.</p> <p>C. Bulk Shipment to Single Destination Which Does Not Control Installation - Bulk shipments from a manufacturing facility covered by the Procedure describing the product to a single destination, where redistribution and installation of the product is not controlled, should be provided with individual sets of use/installation instructions for each product, unless subjected to special consideration.</p> <p>Example: A product shipped in bulk lots to a wholesale or retail outlet where the installation of the equipment will not be under the control of the wholesaler or retailer.</p>

Generic Inspection Instructions

AC1.8.2	Compliance with these guidelines will be determined through a review of the content of the equipment's installation instructions during the product investigation, and information supplied to the UL Inspection Center Representative during inspection visits. Other options that provide an equivalent level of safety or control may be considered based on the application.
AC1.9	<p>Product Variations - In the event that a nonconformance to the Procedure is found, a Variation Notice (VN) will be issued. A VN is a means of communication with the applicant and manufacturer, and forms a record of those items where nonconformance to the Procedure has been found. The VN will indicate the specific model inspected and all other models with similar construction features, even when these models are not individually inspected.</p> <p>Unless directed otherwise by the UL Representative, when a product does not comply with the Procedure, the manufacturer shall either:</p> <ul style="list-style-type: none"> A. Remove any markings referencing UL from the product, packaging, instructions, etc.; or B. Suitably modify all products that do not comply with the Procedure; or C. Hold shipment pending further instructions from UL LLC; or D. Act in accordance with special arrangements made with the Reviewing Office.
AC1.9.1	In the event of a disagreement between the manufacturer and the UL Representative as to whether or not a product is conforming, the manufacturer shall hold production at the factory pending resolution of the variations. The applicant or manufacturer has the right to appeal a decision with which he disagrees and should contact the appropriate UL Office to resolve any disagreements. Should UL LLC grant temporary authorization for the continued use of the UL Mark, such temporary authorization shall only be for the time needed to review and/or process the Procedure revisions, or as otherwise specified to cover a particular lot or production run.

AC2.0	REQUIREMENTS FOR PRODUCTION-LINE TESTS
AC2.1	The following Production-Line Tests shall be conducted on the products covered by this Procedure. During production, the test equipment shall be checked for proper operation at least once during each shift. When the tests are not performed concurrently, it is preferred that the Electric Strength (Dielectric Voltage-Withstand) Test be performed after the Earthing (Grounding) Continuity Test.
AC2.2	Production-Line Earthing (Grounding) Continuity Test
AC2.2.1	General
AC2.2.1.1	<p>For Listed products: Except as may be noted under "Exceptions" in each Test Report, the manufacturer shall subject 100 percent of production of all of the following products to a routine Production-Line Earthing Continuity Test as described in section AC2.2.3.</p> <ul style="list-style-type: none"> A. Products that are provided with a non-detachable earthing type power supply cord, or B. Products that are provided with an earthed type inlet which accepts a detachable power supply cord, or C. Products that are provided with an earthing type terminal block or field wiring (pigtail leads) for permanent connection to the branch circuit.
AC2.2.1.2	For Component Recognized products: When specifically noted in each Test Report, the manufacturer shall subject 100 percent of the specified models to a routine Production-Line Earthing Continuity Test as described in section AC2.2.3.
AC2.2.2	Test Equipment
AC2.2.2.1	Any suitable continuity-indicating device (such as an ohmmeter, a battery and buzzer combination, or the like) may be used to determine compliance with the Earthing Continuity Test requirements. Commercial earth continuity testers that pass a current through the earthing path may also be used to determine compliance with the same requirements.

Generic Inspection Instructions

AC2.2.3	Method
AC2.2.3.1	Continuity shall be determined between the earthing conductor of the attachment plug cap, and/or the designated main protective earthing point, and accessible dead-metal parts of the product, using the test equipment indicated above.
AC2.2.3.2	A single test is sufficient if the accessible metal selected is conductively connected by design to all other accessible metal.
AC2.2.4	Basis for Acceptability
AC2.2.4.1	There shall be earthing continuity between the parts specified.
AC2.2.5	In Cases of Non-conformance
AC2.2.5.1	Any unit that does not conform shall be segregated from conforming units until repaired or otherwise brought into compliance. Records of non-conforming test results shall be retained for six (6) months and shall be readily available for review by the UL Representative. The records shall include the model or catalog designation of the product, the date of production of the unit, the date the test was performed, test results and action taken on rejection.
AC2.3	Production-Line Electric Strength (Dielectric Voltage-Withstand) Test
AC2.3.1	General
AC2.3.1.1	For Listed products: Except as may be noted under "Exceptions" in each Test Report, the manufacturer shall subject 100 percent of production of all products to a routine Production-Line Electric Strength Test as described in section AC2.3.3.
AC2.3.1.2	For Component Recognized products: When specifically noted in each Test Report, the manufacturer shall subject 100 percent of the specified models to a routine Production-Line Electric Strength Test as described in section AC2.3.3.
AC2.3.2	Test Equipment
AC2.3.2.1	The test equipment shall include a means of indicating the test potential, an audible or visual indicator of electrical breakdown, and either a manually operated reset device to restore the equipment after electrical breakdown or an automatic feature that rejects any unacceptable unit. If an ac test potential is applied, the test equipment shall also include a transformer having an essentially sinusoidal output.
AC2.3.2.2	If the output of the test-equipment transformer is less than 500 volt-amperes, the equipment shall include a voltmeter in the output circuit to indicate the test potential directly.
AC2.3.2.3	If the output of the test-equipment transformer is 500 volt-amperes or more, the test potential may be indicated (1) by a voltmeter in the primary circuit or in a tertiary-winding circuit, (2) by a selector switch marked to indicate the test potential, or (3), in the case of equipment having a single test-potential output, by a marking in a readily visible location to indicate the test potential. When marking is used without an indicating voltmeter, the equipment shall include a positive means, such as an indicator lamp, to indicate that the manually operated reset switch has been reset following a dielectric breakdown.
AC2.3.2.4	Test equipment other than that described above may be used when it can be shown that UL has previously confirmed in writing that the equipment complies with the above requirements and is deemed suitable for use for this test.

Generic Inspection Instructions

AC2.3.3	Method
AC2.3.3.1	<p>Each product shall withstand without electrical breakdown, as a routine production-line test, the application of an ac potential at a frequency within the range of 40-70 Hz or a dc potential between (a) the primary wiring, including connected components, and (b) accessible dead metal parts that are likely to become energized.</p> <p>For purposes of these instructions, primary wiring encompasses input wiring for connection to power systems associated with both ac mains and dc mains that exceeds 60 V dc.</p> <p>Note: See the Specific Inspection Criteria in each Test Report for details or special instructions for test locations, such as testing of enamel coating on signal transformers associated with TNV circuits per 2.3.2 and 6.2.1 of UL 60950/-1.</p>
AC2.3.3.2	When there are capacitors across the insulation under test, it is recommended that dc test voltages be used.
AC2.3.3.3	The production-line test potential for paragraph AC2.3.3.1 shall be in accordance with Table AC1 for protectively earthed (Class I) products and Table AC2 for double insulated (Class II) products, as applicable. The full test potential is to be applied for 1 second. The manufacturer's test conditions may be higher than those shown in Tables AC1 and AC2 when necessary to comply with other international product safety certifications.
AC2.3.3.4	The product may be in a heated or unheated condition for the test.
AC2.3.3.5	<p>The test shall be conducted when the product is complete (fully assembled), and it is not intended that the product be unwired, modified, or disassembled for the test, unless otherwise permitted below:</p> <p>A. A part, such as a snap cover or a friction-fit knob, that would interfere with conducting the test need not be in place.</p> <p>B. The test may be conducted before final assembly if the test parameters represent that for the completed product.</p> <p>C. The test need not be performed using the power supply cord provided with the product. However, if the manufacturer's test method employs a test power supply cord, then the continuity of the test power supply cord conductive connections shall be checked once daily.</p>
AC2.3.3.6	For the test, either a sufficient number of control devices are to be closed, or separate applications of the test potential are to be made, so that all parts of the primary circuit are tested.
AC2.3.3.7	<p>During the test, the primary switch is to be in the on position, both sides of the primary circuit of the product are to be connected together and to one terminal of the test equipment, and the second test-equipment terminal is to be connected to accessible dead metal, except as permitted below:</p> <p>A. A product (resistive, high-impedance winding, or the like) having circuitry not subject to excessive secondary voltage buildup in case of electrical breakdown during the test may be tested (1) with a single-pole primary switch, if used, in the off position, or (2) with only one side of the primary circuit connected to the test equipment when the primary switch is in the on position or when a primary switch is not used.</p> <p>B. The primary switch is not required to be in the on position if the testing means applies full test potential between the primary wiring and dead metal parts with the switch not in the on position.</p>
AC2.3.3.8	When authorized by the "Exceptions" included in each Test Report, solid-state components that might be damaged by a secondary effect (induced voltage surge, excessive heating, and the like) of the test may be short-circuited by means of a temporary electrical jumper or the test may be conducted without the component electrically connected, providing the wiring and terminal spacings are maintained. Transient voltage suppression devices other than capacitors connected from primary wiring to dead metal may also be disconnected during the test.

Generic Inspection Instructions

AC2.3.4	Basis for Acceptability
AC2.3.4.1	All products shall withstand the applied potential without an indication of electrical breakdown.
AC2.3.5	In Cases of Non-conformance
AC2.3.5.1	Any unit that does not conform when tested at the values as specified in Table AC1 or AC2 shall be segregated from conforming units until repaired or otherwise brought into compliance. Records of non-conforming test results shall be retained for six (6) months and shall be readily available for review by the UL Representative. The records shall include the model or catalog designation of the product, the date of production of the unit, the date the test was performed, test results and action taken on rejection.

TABLE AC1
ELECTRIC STRENGTH TEST CONDITIONS
FOR CLASS I (PROTECTIVELY EARTHED) EQUIPMENT

Appliance Voltage Rating	Test Potential (V rms)	Test Potential (V dc)	Time (seconds)
Rated less than or equal to 130 V rms (184 V dc)	1000	1400	1
Rated more than 130 V rms (184 V dc) and less than or equal to 600 V rms (849 V dc)	1500	2100	1

For products with special constructions and test conditions see "Exceptions" in each Test Report.

TABLE AC2
ELECTRIC STRENGTH TEST CONDITIONS
FOR CLASS II (DOUBLE INSULATED) EQUIPMENT

Appliance Voltage Rating	Test Potential (V rms)	Test Potential (V dc)	Time (seconds)
Rated less than or equal to 130 V rms (184 V dc)	2000	2800	1
Rated more than 130 V rms (184 V dc) and less than or equal to 600 V rms (849 V dc)	3000	4200	1

For products with special constructions and test conditions see "Exceptions" in each Test Report.

Generic Inspection Instructions

PART AD

GENERAL TERMINOLOGY

AD1.0	ABBREVIATIONS / DEFINITIONS	
AD1.1	Bounding Surface	The outer surface of the electrical enclosure, considered as though metal foil was pressed into contact with accessible surfaces of insulating material
AD1.2	Clearance	Shortest distance between two conductive parts or between a conductive part and the BOUNDING SURFACE of the equipment, measured through air
AD1.3	Creepage Distance	Shortest distance between two conductive parts, or between a conductive part and the BOUNDING SURFACE of the equipment, measured along the surface of the insulation
AD1.4	Extra Low Voltage (ELV)	A secondary circuit with voltages between any two conductors of the circuit, and between any one such conductor and earth, not exceeding 42.4 V peak, or 60 V dc, under normal operating conditions, which is separated from a HAZARDOUS VOLTAGE CIRCUIT by basic insulation, and which neither meets all of the requirements for an SELV circuit nor meets all of the requirements for a LIMITED CURRENT CIRCUIT.
AD1.5	Hazardous Energy Level (HAZ/EL)	An available power level of 240 VA or more having a duration of 60 s or more, or a stored energy level of 20 J or more, at a potential of 2 V or more.
AD1.6	Hazardous Voltage (HAZ/V)	A voltage exceeding 42.4 V peak, or 60 V dc, existing in a circuit that does not meet the requirements for either a LIMITED CURRENT CIRCUIT or a TNV CIRCUIT.
AD1.7	Limited Current Circuit (LCC)	A circuit which is so designed and protected, that, under both normal operating conditions and single fault conditions, the current which can be drawn is not hazardous
AD1.8	Limited Power Source (LPS)	A circuit which includes a transformer or battery, and which is either inherently limited to power levels considered not a risk of fire, or is not inherently limited and requires an over-current protective device to limit the source to power levels considered not a risk of fire
AD1.9	Primary (PRI)	A circuit that is directly connected to the ac mains supply. It includes, for example, the means for connection to the ac mains supply, the primary windings of transformers, motors and other loading devices.
AD1.10	Safety Extra Low Voltage (SELV)	A SECONDARY CIRCUIT which is so designated and protected that under normal operating conditions and single fault conditions, its' voltages do not exceed a safe value, generally 42.2 V peak or 60 V dc.
AD1.11	Secondary (SEC)	A circuit that has no direct connection to a PRIMARY CIRCUIT and derives its power from a transformer, converter or equivalent isolation device, or from a battery.
AD1.12	TNV Circuit	A telecommunications network voltage circuit, which is in the equipment and to which the accessible area of contact is limited, and that is so designed and protected that, under normal operating conditions and single fault conditions, the voltages do not exceed specified limit values based upon the type of TNV circuit.

Generic Inspection Instructions

PART AE

GENERAL PRODUCT CONSTRUCTION REQUIREMENTS

AE1.0	CONSTRUCTION DETAILS
AE1.1	Unless otherwise described or supplemented in individual Test Reports, the requirements specified in Table AE1 apply to all equipment included in this Procedure
AE1.2	All clause references are from the Standard for Safety of Information Technology Equipment, UL 60950, Third Edition and UL 60950-1, First Edition.

TABLE AE1
CONSTRUCTION DETAILS



Clause	Clause Title	Clause Specifics
		None specified

Generic Inspection Instructions

PART AF

UL CERTIFICATION MARK

<i>Product Category:</i>	Audio/video, Information and Communication Technology Equipment - Component
<i>Product Category CCN:</i>	AZOT2



AF1.1	The Test Report covering each product must be consulted to determine which Component Recognition Marks are authorized for use in conjunction with that product.
AF1.2	The Component Recognition Mark consists of up to four elements that are placed in close proximity to each other and shall appear on Recognized products only.
AF1.2.1	Element 1 (Required) – Recognized Company’s identification that may consist of company name, trademark or tradename as specified in individual Test Reports or UL Procedure. Required on all products.
AF1.2.2	Element 2 (Required) - Catalog, model or other product designation as specified in individual Test Reports. Required on all products.
AF1.2.3	Element 3 (Required) - Where Rebuilt products are authorized in individual Test Reports, the word “REBUILT”, “REMANUFACTURED”, or “RECONDITIONED”, as appropriate.
AF1.2.4	Element 4 (Required) - UL Symbol.
AF1.2.4.1	<p>Either of the following Symbols is authorized <u>and required</u></p> <p style="text-align: center;">Option 1 - US only:</p> <div style="text-align: right;">  </div> <p style="text-align: center;">Option 2 - US + Canada:</p> <div style="text-align: right;">  </div>
AF1.2.4.2	There is no required minimum height for the UL Symbol, as long as it is legible. The minimum height of the registered trademark symbol ® shall be 3/64 of an inch. When the overall diameter of the UL Symbol is less than 3/8 of an inch, the trademark symbol may be omitted if it is not legible to the naked eye. Information on downloading electronic versions or receiving camera-ready artwork of the UL Symbols may be obtained at www.ul.com
AF1.3	The Listing or Classification Mark of UL LLC is not authorized for use on or in connection with Recognized Components. Only those components that actually bear the above Component Recognition Mark should be considered as being covered under the Component Recognition Program.
AF1.4	The manufacturer may reproduce the Component Recognition Mark or obtain it from a UL authorized supplier.

Generic Inspection Instructions

PART AF

UL CERTIFICATION MARK

<i>Product Category:</i>	Audio/video, Information and Communication Technology Equipment - Component
<i>Product Category CCN:</i>	AZOT8

AF1.1	The Test Report covering each product must be consulted to determine which Component Recognition Marks are authorized for use in conjunction with that product.
AF1.2	The Component Recognition Mark consists of four elements that are placed in close proximity to each other and shall appear on Recognized products only.
AF1.2.1	Element 1 (Required) – Recognized Company's identification that may consist of company name, trademark or tradename as specified in individual Test Reports or UL Procedure. Required on all products.
AF1.2.2	Element 2 (Required) - Catalog, model or other product designation as specified in individual Test Reports. Required on all products.
AF1.2.3	Element 3 (Required) - Where Rebuilt products are authorized in individual Test Reports, the word "REBUILT", "REMANUFACTURED", or "RECONDITIONED", as appropriate.
AF1.2.4	Element 4 (Required) – UL Symbol.
AF1.2.4.1	<p>Either of the following Symbols is authorized <u>and required</u>:</p> <p style="text-align: center;">Option 1 - Canada only: </p> <p style="text-align: center;">Option 2 - US + Canada: </p>
AF1.2.4.3	There is no required minimum height for the UL Symbol, as long as it is legible. The minimum height of the registered trademark symbol ® shall be 3/64 of an inch. When the overall diameter of the UL Symbol is less than 3/8 of an inch, the trademark symbol may be omitted if it is not legible to the naked eye. Information on downloading electronic versions or receiving camera-ready artwork of the UL Symbols may be obtained at www.ul.com
AF1.3	The Listing or Classification Mark of UL LLC is not authorized for use on or in connection with Recognized Components. Only those components that actually bear the above Component Recognition Mark should be considered as being covered under the Component Recognition Program.
AF1.4	The manufacturer may reproduce the Component Recognition Mark or obtain it from a UL authorized supplier.

CERTIFICATE OF COMPLIANCE

Certificate Number UL-US-2247925-0
Report Reference E530382-20221222
Date 3-Jan-2023

Issued to: 2N TELEKOMUNIKACE a.s.
Modranska 621/72
143 01 Praha 4 Prague 143 01
Czech Republic

This is to certify that representative samples of AZOT2 - Audio/Video, Information and Communication Technology Equipment - Component

See Addendum Page for Product Designation(s).

Have been evaluated by UL in accordance with the component requirements in the Standard(s) indicated on this Certificate. UL Recognized components are incomplete in certain constructional features or restricted in performance capabilities and are intended for installation in complete equipment submitted for investigation to UL LLC.

Standard(s) for Safety: UL 62368-1, 3rd Ed., Issue Date: 2019-12-13, Revision Date: 2021-10-22

Additional Information: See the UL Online Certifications Directory at <https://iq.ulprospector.com> for additional information

This Certificate of Compliance indicates that representative samples of the product described in the certification report have met the requirements for UL certification. It does not provide authorization to apply the UL Recognized Component Mark. Only the Authorization Page that references the Follow-Up Services Procedure for ongoing surveillance provides authorization to apply the UL Mark.

Only those products bearing the UL Recognized Component Mark should be considered as being UL Certified and covered under UL's Follow-Up Services.

Look for the UL Recognized Component Mark on the product.

Deborah Jennings-Conner, VP Regulatory Services

UL LLC

Any information and documentation involving UL Mark services are provided on behalf of UL LLC (UL) or any authorized licensee of UL. For questions, please contact a local UL Customer Service Representative at <http://ul.com/aboutul/locations/>



CERTIFICATE OF COMPLIANCE

Certificate Number UL-US-2247925-0
Report Reference E530382-20221222
Date 3-Jan-2023

This is to certify that representative samples of the product as specified on this certificate were tested according to the current UL requirements

Model	Category Description
2N LiftIP 2.0	AV, ITE, and AVICT Equipment
2N LiftIP 2.0 relay extender	AV, ITE, and AVICT Equipment
2N Voice Alarm Station Audio Unit	AV, ITE, and AVICT Equipment
2N Voice Alarm Station Switch	AV, ITE, and AVICT Equipment

Deborah Jennings-Conner, VP Regulatory Services



UL LLC

Any information and documentation involving UL Mark services are provided on behalf of UL LLC (UL) or any authorized licensee of UL. For questions, please contact a local UL Customer Service Representative at <http://ul.com/aboutul/locations/>

CERTIFICATE OF COMPLIANCE

Certificate Number UL-CA-2245651-0
Report Reference E530382-20221222
Date 3-Jan-2023

Issued to: 2N TELEKOMUNIKACE a.s.
Modranska 621/72
143 01 Praha 4 Prague 143 01
Czech Republic

This is to certify that representative samples of AZOT8 - Audio/Video, Information and Communication Technology Equipment Certified for Canada - Component
See Addendum Page for Product Designation(s).

Have been evaluated by UL in accordance with the component requirements in the Standard(s) indicated on this Certificate. UL Recognized components are incomplete in certain constructional features or restricted in performance capabilities and are intended for installation in complete equipment submitted for investigation to UL LLC.

Standard(s) for Safety: CSA C22.2 No. 62368-1:19, 3rd Ed., Issue Date: 2019-12-13, Revision Date: 2021-10-22

Additional Information: See the UL Online Certifications Directory at <https://iq.ulprospector.com> for additional information

This Certificate of Compliance indicates that representative samples of the product described in the certification report have met the requirements for UL certification. It does not provide authorization to apply the UL Recognized Component Mark. Only the Authorization Page that references the Follow-Up Services Procedure for ongoing surveillance provides authorization to apply the UL Mark.

Only those products bearing the UL Recognized Component Mark should be considered as being UL Certified and covered under UL's Follow-Up Services.

Look for the UL Recognized Component Mark on the product.

Deborah Jennings-Conner, VP Regulatory Services

UL LLC

Any information and documentation involving UL Mark services are provided on behalf of UL LLC (UL) or any authorized licensee of UL. For questions, please contact a local UL Customer Service Representative at <http://ul.com/aboutul/locations/>



CERTIFICATE OF COMPLIANCE

Certificate Number UL-CA-2245651-0
Report Reference E530382-20221222
Date 3-Jan-2023

This is to certify that representative samples of the product as specified on this certificate were tested according to the current UL requirements

Model	Category Description
2N LiftIP 2.0	AV, ITE, and AVICT Equipment
2N LiftIP 2.0 relay extender	AV, ITE, and AVICT Equipment
2N Voice Alarm Station Audio Unit	AV, ITE, and AVICT Equipment
2N Voice Alarm Station Switch	AV, ITE, and AVICT Equipment

Deborah Jennings-Conner, VP Regulatory Services



UL LLC

Any information and documentation involving UL Mark services are provided on behalf of UL LLC (UL) or any authorized licensee of UL. For questions, please contact a local UL Customer Service Representative at <http://ul.com/aboutul/locations/>

UL TEST REPORT AND PROCEDURE

Standard:	UL 62368-1, 3rd Ed, 2021-10-22 (Audio/video, information and communication technology equipment Part 1: Safety requirements) CAN/CSA C22.2 No. 62368-1:19, 3rd Ed, 2021-10-22 (Audio/video, information and communication technology equipment Part 1: Safety requirements)
Certification Type:	Component Recognition
CCN:	AZOT2, AZOT8 (Audio/video, Information and Communication Technology Equipment)
Complementary CCN:	N/A
Product:	Lift communication system
Model:	2N LiftIP 2.0 2N Voice Alarm Station Switch 2N LiftIP 2.0 relay extender 2N Voice Alarm Station Audio Unit
Rating:	2N LiftIP 2.0: (optional) PoE: 48 Vdc, 802.3af or 10–30 Vdc, up to 2 W 2N Voice Alarm Station Switch: N/A 2N LiftIP 2.0 relay extender: N/A 2N Voice Alarm Station Audio Unit: N/A
Applicant Name and Address:	2N TELEKOMUNIKACE A.S. MODRANSKA 621/72 143 01 PRAHA 4 143 01 PRAGUE CZECH REPUBLIC

This is to certify that representative samples of the products covered by this Test Report have been investigated in accordance with the above referenced Standards. The products have been found to comply with the requirements covering the category and the products are judged to be eligible for Follow-Up Service under the indicated Test Procedure. The manufacturer is authorized to use the UL Mark on such products which comply with this Test Report and any other applicable requirements of UL LLC ('UL') in accordance with the Follow-Up Service Agreement. Only those products which properly bear the UL Mark are considered as being covered by UL's Follow-Up Service under the indicated Test Procedure.

The applicant is authorized to reproduce the referenced Test Report provided it is reproduced in its entirety.

UL authorizes the applicant to reproduce the latest pages of the referenced Test Report consisting of the first page of the Specific Technical Criteria through to the end of the Conditions of Acceptability.

Any information and documentation involving UL Mark services are provided on behalf of UL LLC (UL) or any authorized licensee of UL.

Prepared By: Grzegorz Osik / Project Handler Reviewed By: Krzysztof Rycharski / Reviewer

Supporting Documentation

The following documents located at the beginning of this Procedure supplement the requirements of this Test Report:

- A. Authorization - The Authorization page may include additional Factory Identification Code markings.
- B. Generic Inspection Instructions -
- i. Part AC details important information which may be applicable to products covered by this Procedure. Products described in this Test Report must comply with any applicable items listed unless otherwise stated in the body of this Test Report.
 - ii. Part AE details any requirements which may be applicable to all products covered by this Procedure. Products described in this Test Report must comply with any applicable items listed unless otherwise stated in the body of each Test Report.
 - iii. Part AF details the requirements for the UL Certification Mark which is not controlled by the technical standard used to investigate these products. Products are permitted to bear only the Certification Mark(s) corresponding to the countries for which it is certified, as indicated in each Test Report.

Product Description

Product is a Lift communication system consists of 2N LiftIP 2.0 module and three accessories:

- 2N Voice Alarm Station Switch
- 2N LiftIP2.0 relay extender
- 2N Voice Alarm Station Audio Unit

Model Differences

2N LiftIP 2.0 is an lift communicator providing full-duplex audio transmission via the VoIP technology directly from the lift cabin. A microphone and a speaker are built-in behind the lift panel for bidirectional communication.

2N Voice Alarm Station Switch helps interconnect 2N LiftIP 2.0 with one or two audio units.

2N LiftIP2.0 relay extender extends 2N LiftIP 2.0 to include one additional output.

2N Voice Alarm Station Audio Unit extends 2N LiftIP 2.0 to include audio units on the cabin roof and under the cabin. It is equipped with its own microphone, speaker and emergency button.

Test Item Particulars

Product group	built-in component
Classification of use by	Ordinary person Children likely to be present
Supply Connection	not mains connected: ES1
Supply tolerance	None
Supply connection – type	mating connector PoE or DC In
Considered current rating of protective device	N/A
Equipment mobility	stationary wall/ceiling-mounted
Over voltage category (OVC)	OVC II
Class of equipment	Class III

Special installation location	N/A
Pollution degree (PD)	PD 2
Manufacturer's specified Tma (°C)	50
IP protection class	IPX0
Power systems	not AC mains
Altitude during operation (m)	2000 m or less
Altitude of test laboratory (m)	2000 m or less
Mass of equipment (kg)	2N LiftIP 2.0 – 0.38 kg 2N Voice Alarm Station Switch – 0.06 kg 2N LiftIP2.0 relay extender – 0.005 kg 2N Voice Alarm Station Audio Unit – 0.26 kg

Technical Considerations

- The product was submitted and evaluated for use at the maximum ambient temperature (Tma) permitted by the manufacturer's specification of : 50°C
- The product is intended for use on the following power systems : No direct connection
- Considered current rating of protective device as part of the building installation (A) : N/A
- The equipment disconnect device is considered to be : N/A
- The Risk Group of a lamp or lamp system (including LEDs) is : Exempt
- The following scope limitations apply to this test report and additional evaluation and/or tests may be required when submitting this CB Report to a National Certification Body (NCB) to obtain a national mark:
 - no EMC tests nor evaluation to EMC Directive 2004/108/EC and 2014/30/EU
 - no evaluation to RoHS Directives 2002/95/EC, 2011/65/EU and (EU) 2016/585
 - no evaluation to Council Recommendation 1999/519/EC nor 2006/25/EC
- Unit has to be supplied by a power supply specified as a Limited Power Source (LPS) or PS2 source of supply acc. to UL/IEC 60950-1 (latest ed) or UL/IEC 62368-1

Engineering Conditions of Acceptability

For use only in or with complete equipment where the acceptability of the combination is determined by UL LLC. When installed in an end-product, consideration must be given to the following:

- The following output circuits are at ES1 energy levels : All outputs
- The following output circuits are at PS2 energy levels : All outputs
- The investigated Pollution Degree is : 2
- The following end-product enclosures are required : Electrical, Mechanical
- None of the requirements from UL 2017 have been evaluated and this may need to be done in the end-product.

Additional Information

During the tests the units were loaded as declared by the manufacturer. See Enclosure 07-01.

Additional Standards

The product fulfills the requirements of: UL 62368-1 3rd Edition, Revised October 22, 2021, CAN/CSA C22.2 No. 62368-1:19, 3rd Edition, Revised October 22, 2021, EN IEC 62368-1:2020+A11:2020

Markings and Instructions

Clause Title	Marking or Instruction Details
--------------	--------------------------------

Equipment identification marking – Manufacturer identification	Listee's or Recognized Company's name, Trade Name, Trademark or File Number
Equipment identification marking – model identification	Model Number
Special Instructions to UL Representative N/A	

BD1.0						
TABLE: Production-Line Testing Requirements						
BD1.1						
Electric Strength Test Special Constructions – Refer to Generic Inspection Instructions, Part AC for further information.						
Model	Component	Removable parts	Test probe location	Test V rms	Test V dc	Test Time, s
-	-	-	-	-	-	-
BD1.2						
Earthing Continuity Test Exemptions – This test is not required for the following models:						
All						
BD1.3						
Electric Strength Test Exemptions – This test is not required for the following models:						
All						
BD1.4						
Electric Strength Test Component Exemptions – The following solid-state components may be disconnected from the remainder of the circuitry during the performance of this test.						
-						

BE1.0					
Sample and Test Specifics for Follow-Up Tests at UL					
Model	Component	Material	Test	Sample (s)	Test Specifics
-	-	-	-	-	-

4.1.2	TABLE: List of critical components					Pass
Object / part No.	Manufacturer/ trademark	Type / model	Technical data	Product Category CCN(s)	Mark(s) of conformity	Supplement ID
2N LiftIP 2.0 module consists of:	-	-	-	-	-	
Front plate	Interchangeable	Interchangeable	Front panel, made in stainless steel , approx. dim. 100 x 220 mm, thickness 2mm	-	-	
Plastic sheet between front plate and PWB	Interchangeable	Interchangeable	Min HB rated in the minimum thickness.	QFMZ2	UL	
PWB cover plate	Interchangeable	Interchangeable	Min HB rated in the minimum thickness.	QFMZ2	UL	
PWB	UNITED ELECTECH LTD	328 ML	V-0, 130 deg. C	ZPMV2	UL (E193317)	
PWB (alternate)	Interchangeable	Interchangeable	min. V-1, Min 130 deg. C	ZPMV2	UL	
PoE connector (X17)	Wittig	E-5JS811EXX43	RJ-45, metal shielded, interior V-2	DUXR, DUXR2	UL	
I/O connectors (X3, X11, X12, X13)	NINGBO DEGSON ELECTRICAL CO LTD	DG332K-5.0	300V, 10A, 2 pole, V-0, 120 deg. C	XCFR2, XCFR8	UL (E228872)	
I/O connectors (X4)	NINGBO DEGSON ELECTRICAL CO LTD	DG332K-5.0	300V, 10A, 3 pole, V-0, 120 deg. C	XCFR2, XCFR8	UL (E228872)	
Fuse (F1)	Belfuse	C1T	1A, 63V, Int. rating: 50A	JDYX2, JDYX8	UL (E20624)	
PoE flyback transformer (T1)	COILCRAFT INC	POE13P-50L	1500Vrms isolation from primary to aux and secondary. Input rated 36 to 72Vdc. Output rated 5.0 V, 2.6 A. 85 deg C.	NWQG2, NWQG8	UL (E219588)	
Optocoupler (U19)	Toshiba	TLP185	Rated 3750Vac, 110 °C	FPQU2/8	UL (E67349)	

Speaker	Interchangeable	Interchangeable	Min. 16 Ohm, min. 1W	-	-	
Speaker wires	DONGGUAN ZHIHANG TECHNOLOGY CO LTD	10305 style	26AWG, 105 deg C, 300V	AVLV2/8	UL (E358567)	
Accessories	-	-	-	-	-	
LED cable (2 provided) (optional)	SHENZHEN JTK WIRE&CABLE CO LTD	4478 style	26AWG, 105 deg C, 300V	UL (E359216)	AVLV2, AVLV8	
Microphone cable (optional)	XINYA ELECTRONIC CO LTD	1185 style	26AWG, 80 deg C, 300V	UL (E170689)	AVLV2, AVLV8	
Speaker (optional)	Interchangeable	Interchangeable	Min. 16 Ohm, min. 1W	-	-	
Speaker cable (optional)	DONGGUAN ZHIHANG TECHNOLOGY CO LTD	10305 style	26AWG, 105 deg C, 300V	AVLV2/8	UL (E358567)	
End of 2N LiftIP 2.0 module	-	-	-	-	-	
LiftIP 2.0 accessories	-	-	-	-	-	
2N Voice Alarm Station Switch consists of:	-	-	-	-	-	
Enclosure	Lotte Chemical Co.	VH-0800	V-0, 1.5mm min. thickness, 60 deg. C	QFMZ2/8	UL (E115797)	
Enclosure	Interchangeable	Interchangeable	Min V-1 rated in the minimum thickness, min. 60 deg. C	QFMZ2	-	
PWB	interchangeable	interchangeable	min. 130C, min. V-1	ZPMV2	-	
Connector (X1, X2)	interchangeable	RJ12 type 1611	125V, 1A, Min HB rated for plastic part	QFMZ2	-	
Connector (X5)	Molex	WF-10RB A	250V, 3A	QFMZ2	-	

Connector (X5) (alternate)	interchangeable	interchangeable	min. 250V, min. 3A, Min HB rated for plastic part	QFMZ2	-	
End of 2N Voice Alarm Station Switch	-	-	-	-	-	
2N LiftIP2.0 relay extender consists of:	-	-	-	-	-	
PWB	SHENZHEN HOPESEARCH PCB MANUFACTURING CO LTD	F-D	V-0, 130 deg. C	ZPMV2	UL(E351308)	
Relay	Takamisawa Electric	A5W-K	Contacts: 125VAC, 2.0A max., V-0	NRNT2	UL (E45026)	
Connector (X2)	CIXI KAIFENG ELECTRONICS CO LTD	KF124-3.5 03P 1G	150V, 10A, 105 deg. C, Min HB rated for plastic part	QFMZ2	-	
Wires	AlphaWire	1061 style	VW-1, 24 AWG, 300V, 80 deg. C	AVLV2/8	UL (E163869)	
Wires (alternate)	Interchangeable	Interchangeable	min. VW-1, min. 300 V, min. 80 °C, min. 24 AWG	AVLV2/8	UL	
End of 2N LiftIP2.0 relay extender	-	-	-	-	-	
2N Voice Alarm Station Audio Unit consists of:	-	-	-	-	-	
Enclosure	Interchangeable	Interchangeable	Min HB rated in the minimum thickness.	QFMZ2	-	
PWB	interchangeable	interchangeable	min. 130C, min. V-1	ZPMV2	-	

Connector (X1)	Interchangeable	RJ12 type 1611	125V, 1A, 80 deg. C	QFMZ2	-	
Speaker	Interchangeable	Interchangeable	Min.16 Ohm, min. 1W	-	-	
Speaker wires	DONGGUAN ZHIHANG TECHNOLOGY CO LTD	10305 style	26AWG, 105 deg C, 300V	AVLV2/8	UL (E358567)	
Foam	Cellofoam	CELLO 461 UL/O	HF-1, 100 deg. C	-	-	
Foam (alternate)	Interchangeable	Interchangeable	min. HF-2, min. 100 deg. C	-	-	
End of accessories list	-	-	-	-	-	
Marking label	Zebra Technologies Corp	Z-Supreme 4000T White	Suitable for application on aluminum, max temp. 175 °C	PGJ12	UL (MH15633)	
Marking label (alternate)	Zebra Technologies Corp	Z-Xtreme 4000T White High Tack	Suitable for application on aluminum, max temp. 150 °C	PGJ12	UL (MH15633)	
Marking label (alternate)	Zebra Technologies Corp	Z-Xtreme 4000T Silver High Tack	Suitable for application on aluminum, max temp. 150 °C	PGJ12	UL (MH15633)	
Marking label (alternate)	Zebra Technologies Corp	Z-Ultimate 3000T White	Suitable for application on aluminum, max temp. 150 °C	PGJ12	UL (MH15633)	
Marking label (alternate)	Zebra Technologies Corp	Z-Ultimate 3000T Silver	Suitable for application on aluminum, max temp. 150 °C	PGJ12	UL (MH15633)	
Marking label (ink)	Zebra Technologies Corp	Type 5095 resin	Thermal transfer ribbon	PGGU2	UL (MH63997)	

Marking label (ink) (alternate)	Zebra Technologies Corp	Type 5095 resin	Thermal transfer ribbon	PGGU2	UL (MH63641)	
------------------------------------	----------------------------	-----------------	-------------------------	-------	--------------	--

Enclosures

Type	Supplement Id	Description
Photographs	03-01	2N LiftIP front panel
Photographs	03-02	2N LiftIP bottom view
Photographs	03-03	2N LiftIP PWB cover
Photographs	03-04	2N LiftIP top PWB view
Photographs	03-05	2N Voice Alarm Station Switch with interconnecting cable
Photographs	03-06	2N Voice Alarm Station Switch side view
Photographs	03-07	2N Voice Alarm Station Switch disassembling view
Photographs	03-08	2N Voice Alarm Station Switch PWB
Photographs	03-09	2N Voice Alarm Station Switch PWB bottom
Photographs	03-10	2N LiftIP2.0 relay extender PWB top
Photographs	03-11	2N LiftIP2.0 relay extender bottom
Photographs	03-12	2N Voice Alarm Station Audio Unit
Photographs	03-13	2N Voice Alarm Station Audio Unit bottom view
Photographs	03-14	2N Voice Alarm Station Audio Unit inside view 2
Photographs	03-15	2N Voice Alarm Station Audio Unit inside view 3
Photographs	03-16	2N Voice Alarm Station Audio Unit inside view
Photographs	03-17	2N Voice Alarm Station Audio Unit PWB
Schematics + PWB	05-01	LiftIP PWB component layout top
Schematics + PWB	05-02	LiftIP PWB component layout bottom
Schematics + PWB	05-03	Voice Alarm Station Switch PWB layout top
Schematics + PWB	05-04	Voice Alarm Station Switch PWB layout bottom
Schematics + PWB	05-05	LiftIP relay extender PWB layout top
Schematics + PWB	05-06	LiftIP relay extender PWB layout bottom
Schematics + PWB	05-07	Voice Alarm Station Audio Unit PWB layout top
Schematics + PWB	05-08	Voice Alarm Station Audio Unit PWB layout bottom
Miscellaneous	07-01	MNL instruction

The following Page(s) are related to Miscellaneous-01. The next supplement, if applicable, will be identified with a new Supplement Page Heading.

2N® Lift IP 2.0 - schema for testing

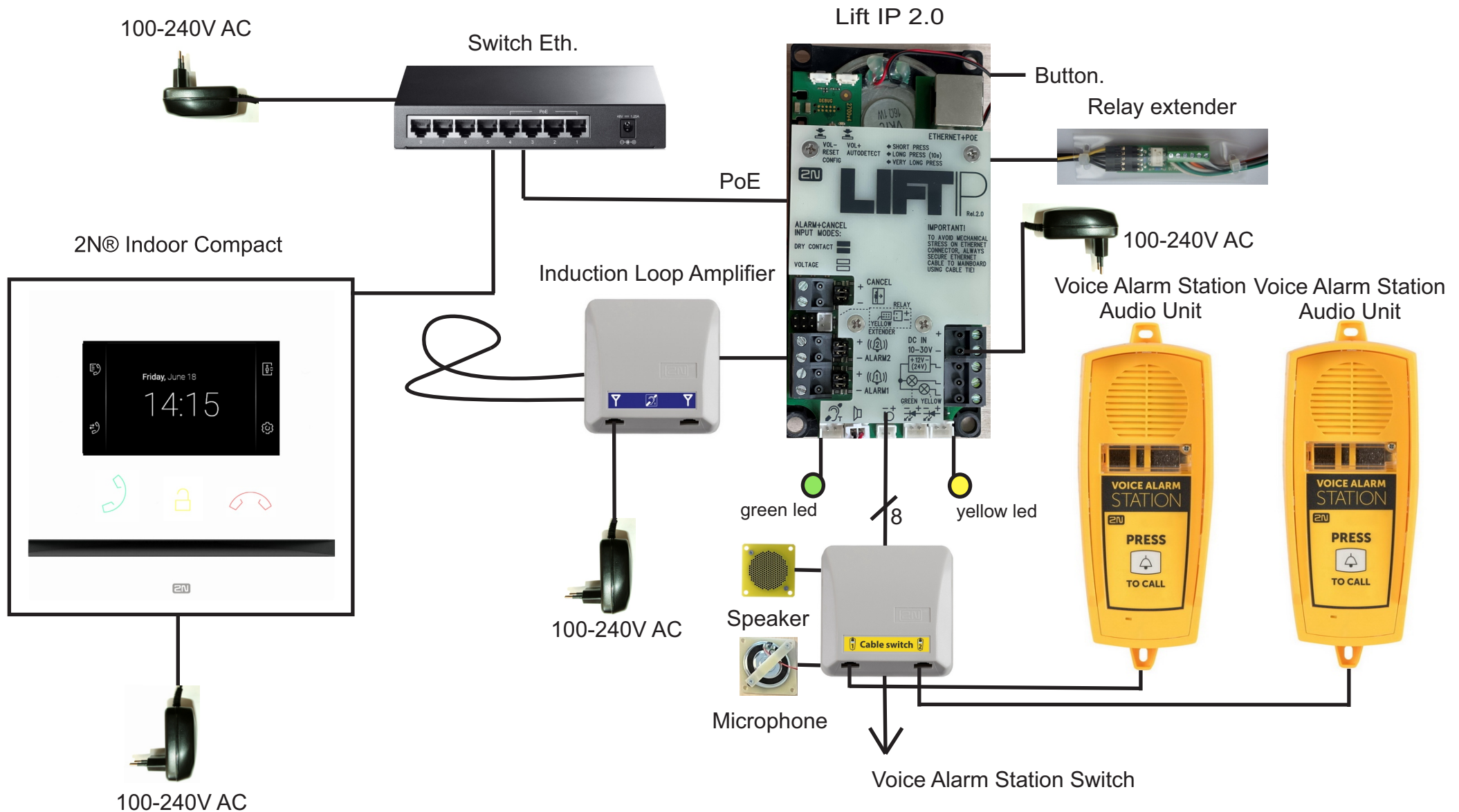



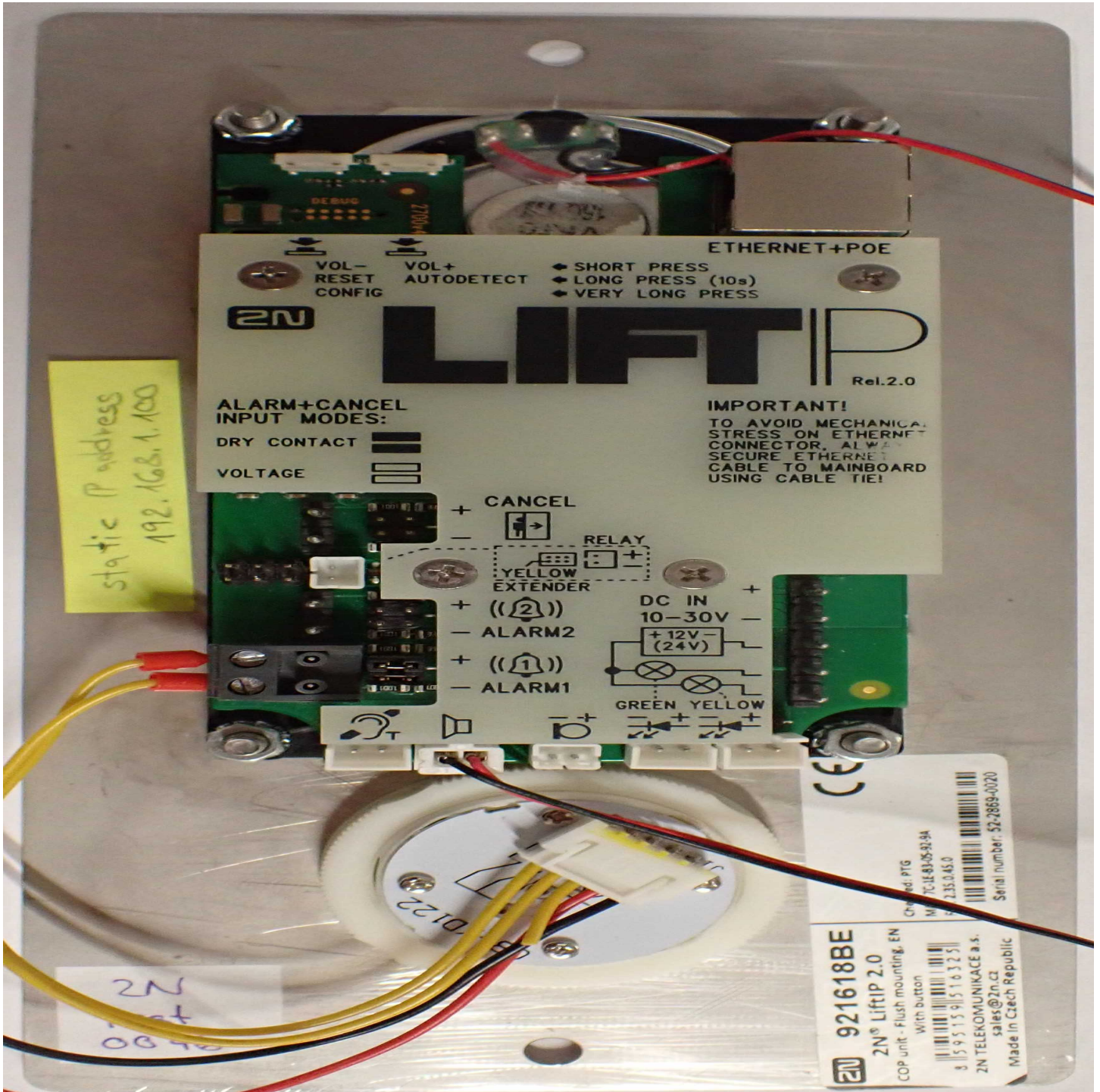

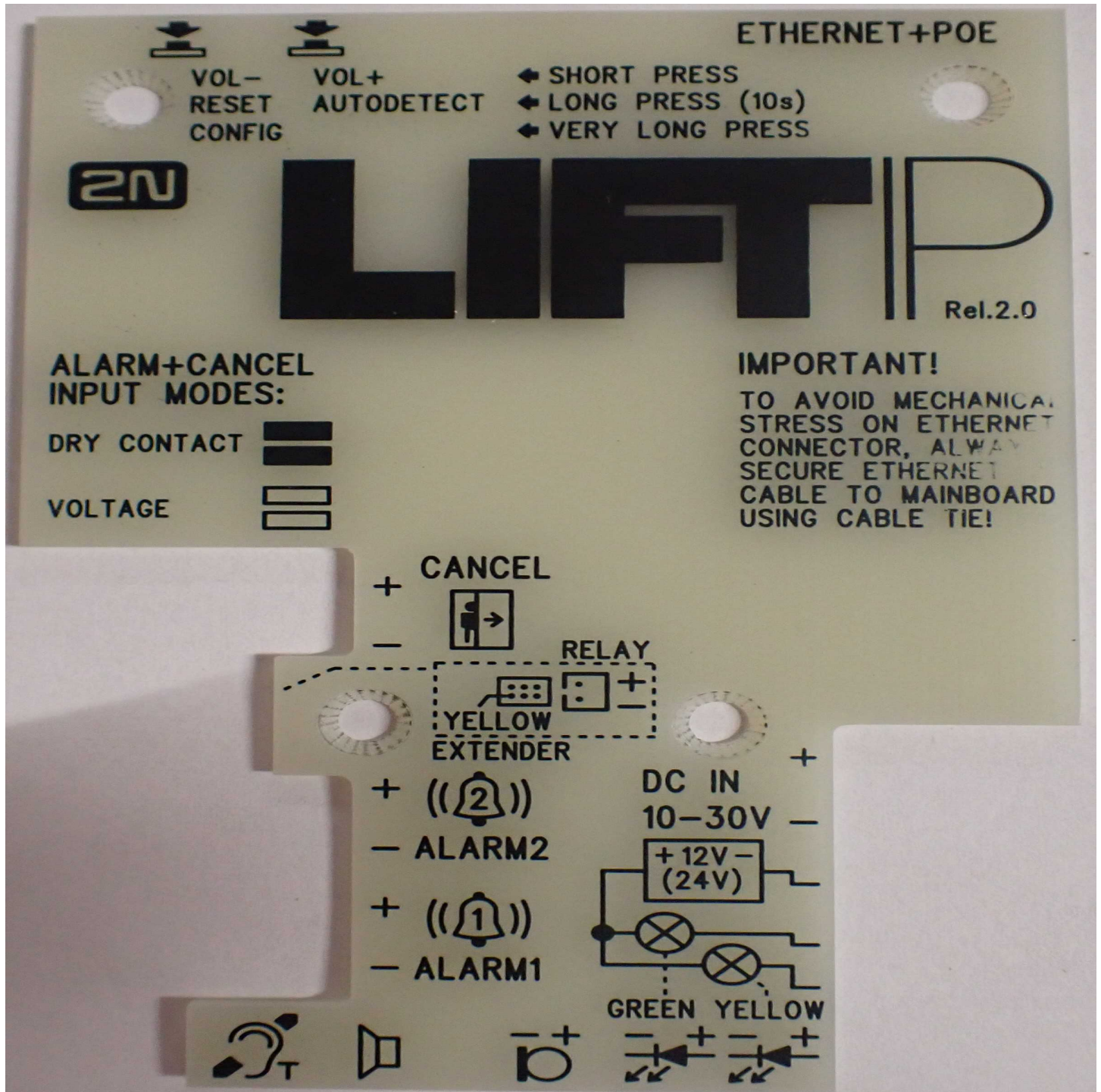

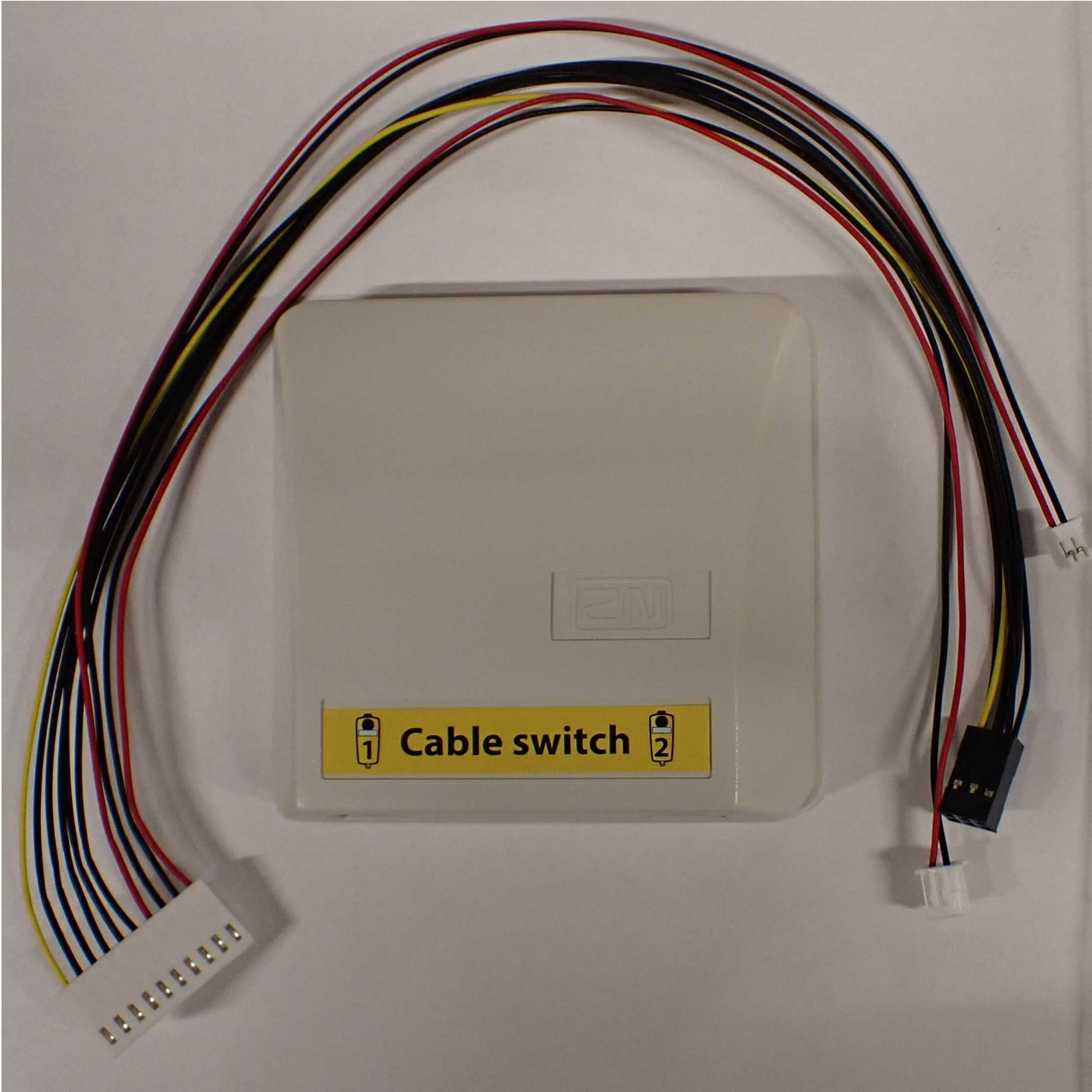



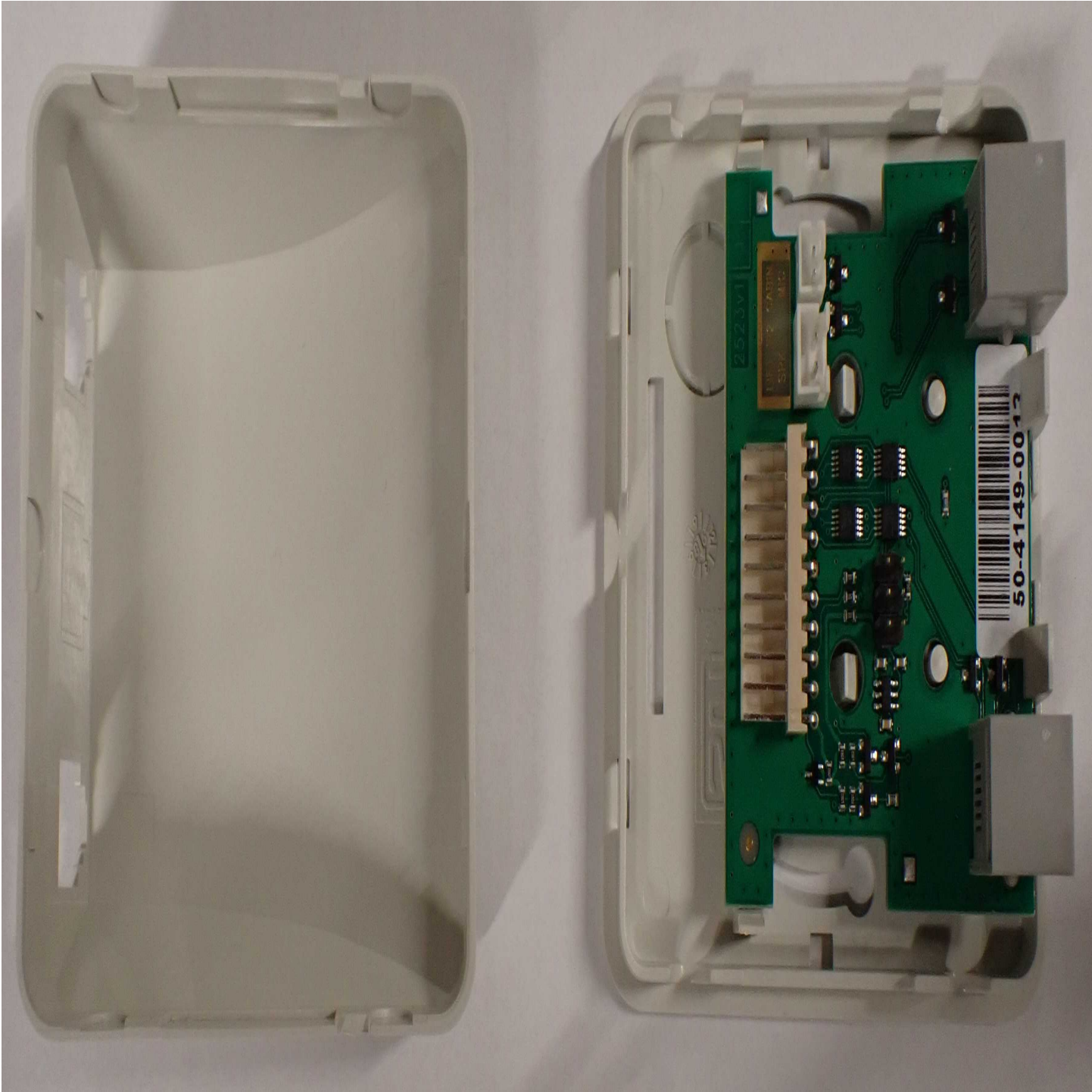

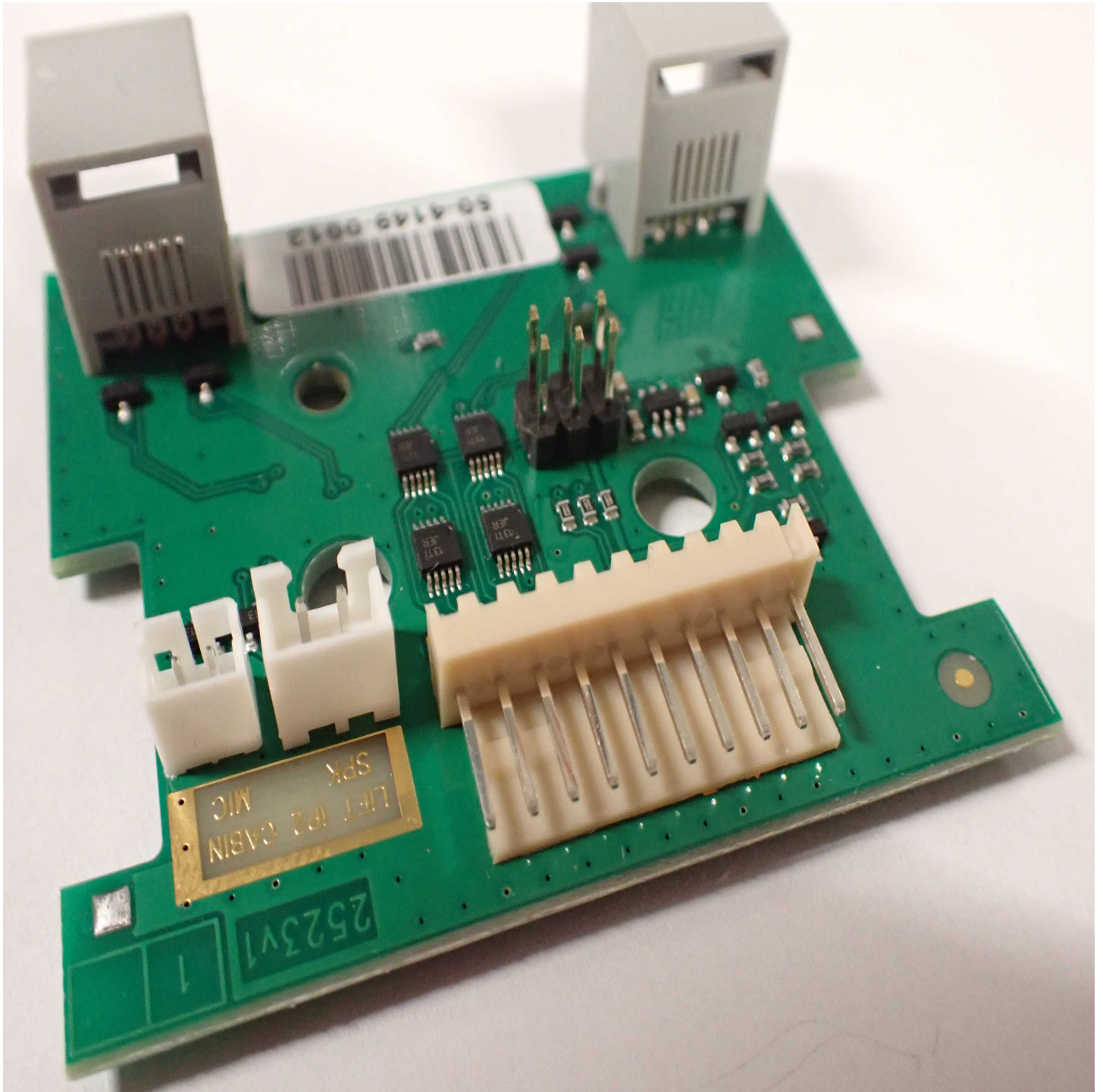

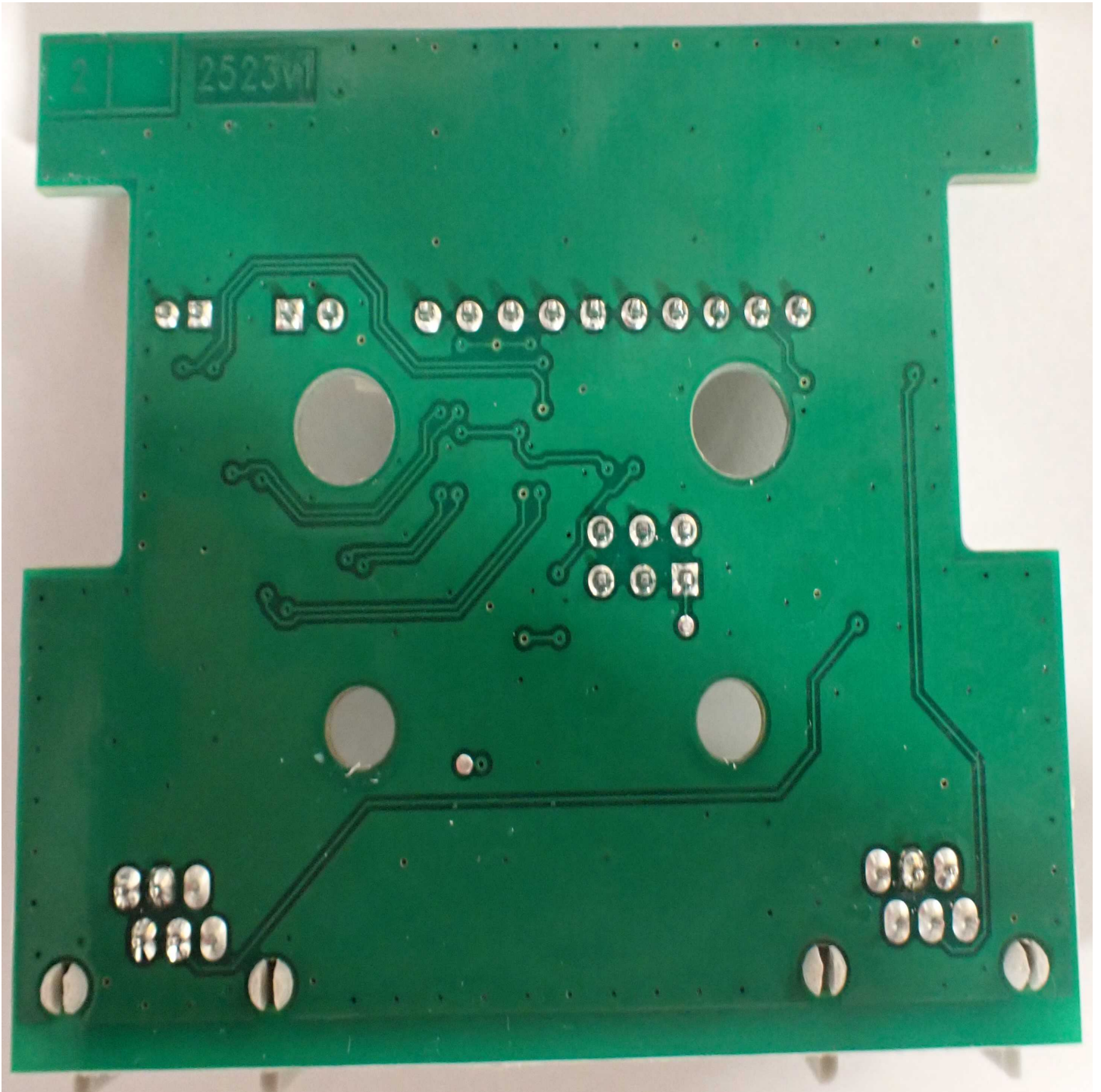



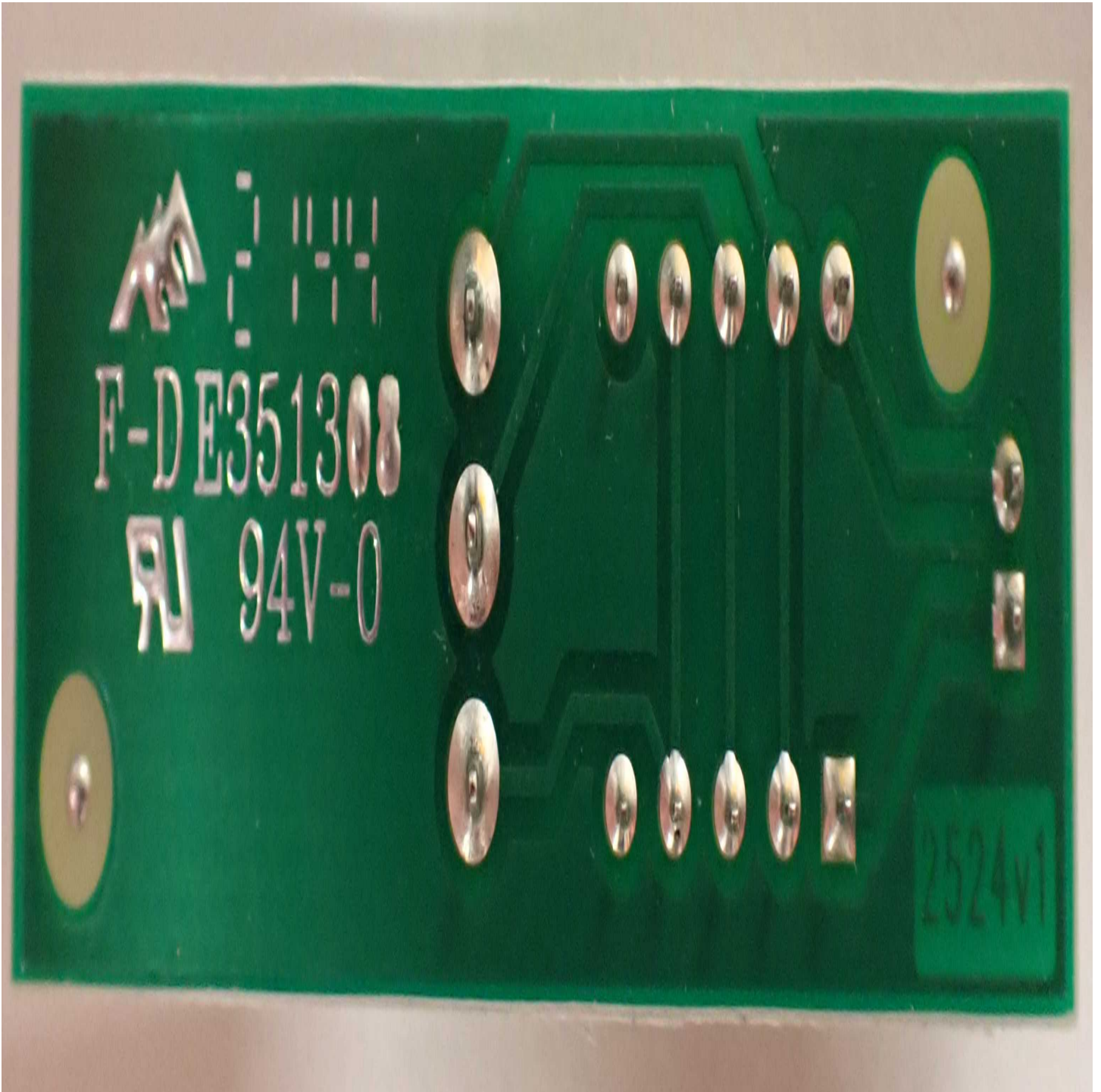





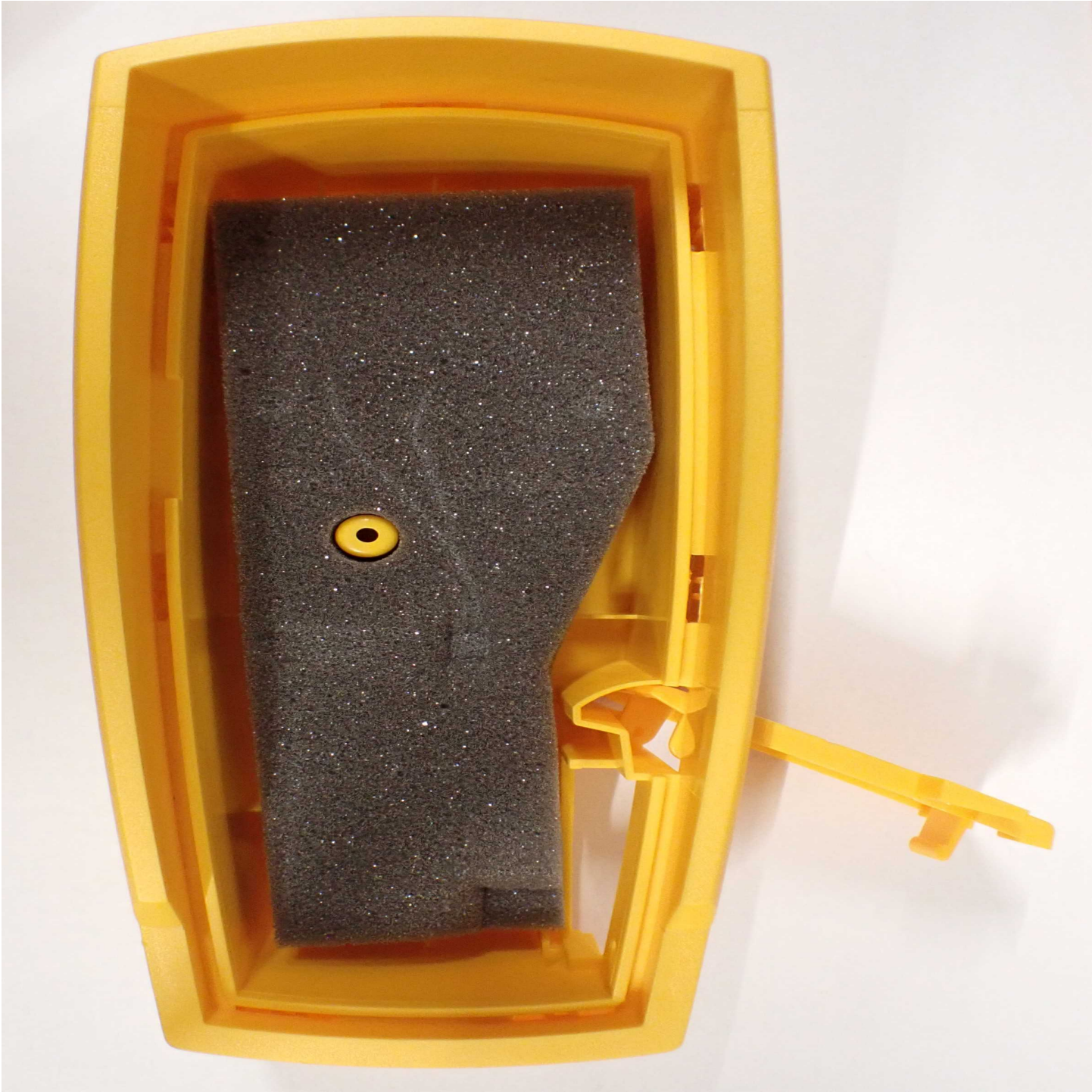



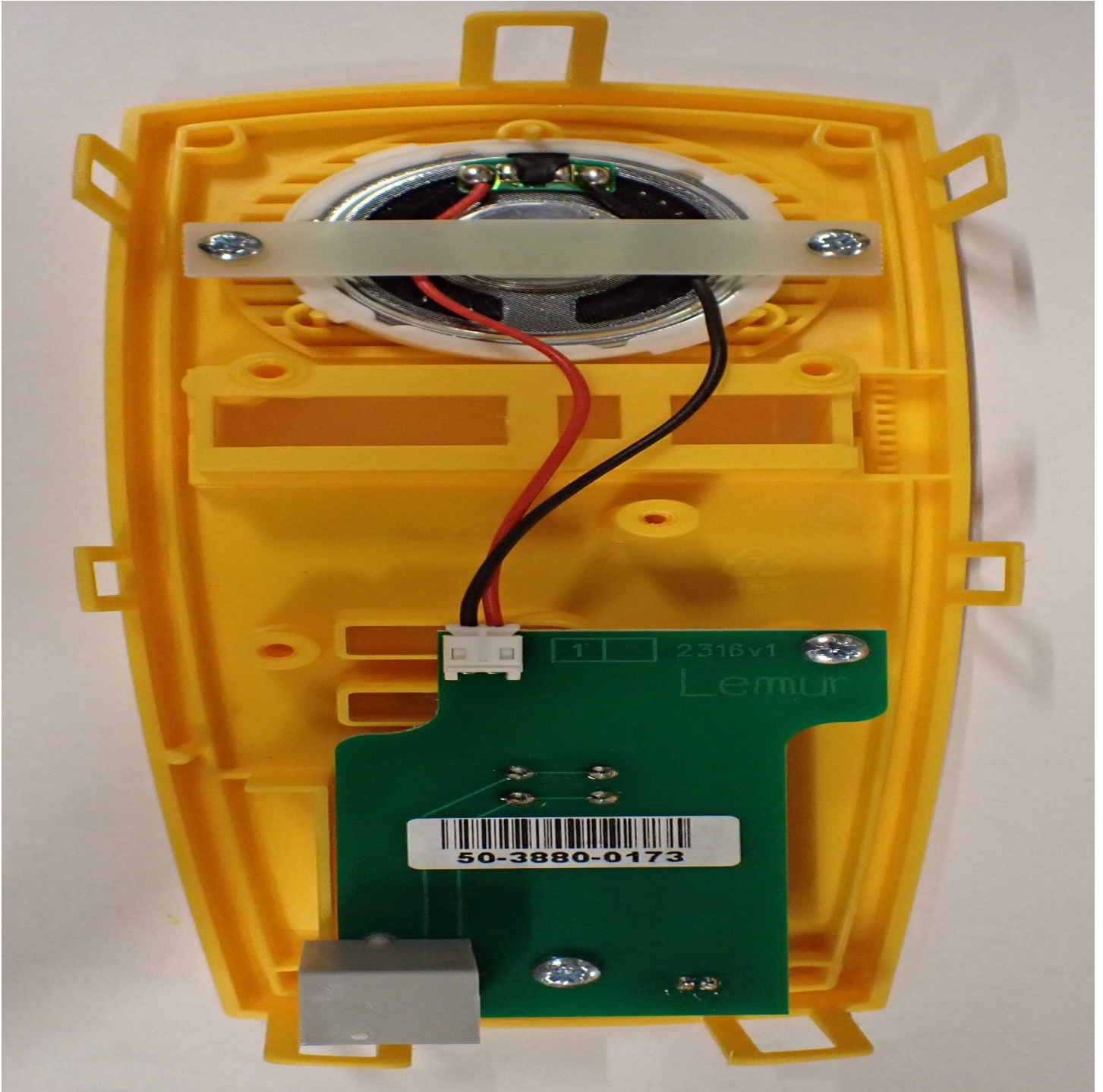

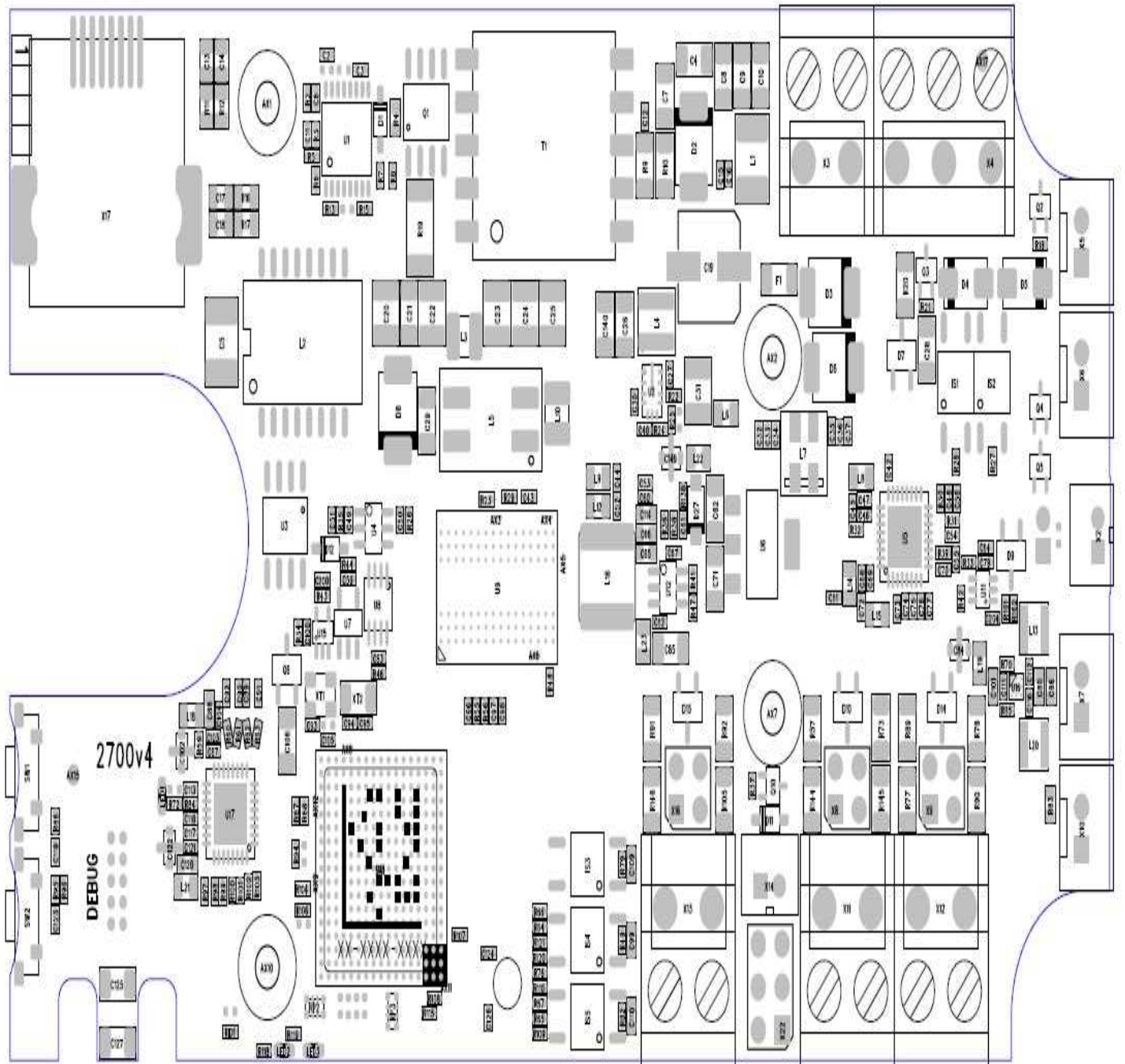

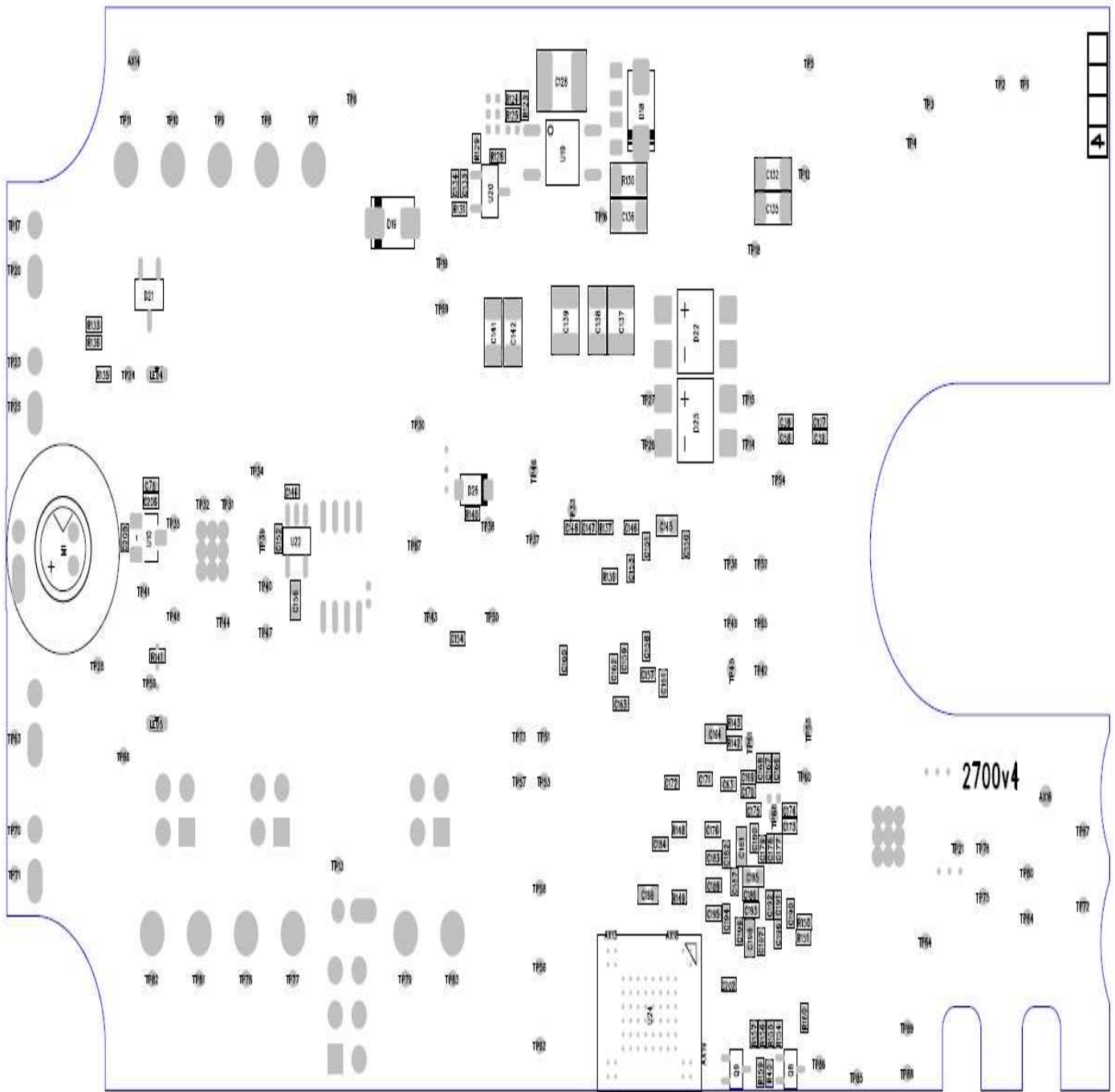

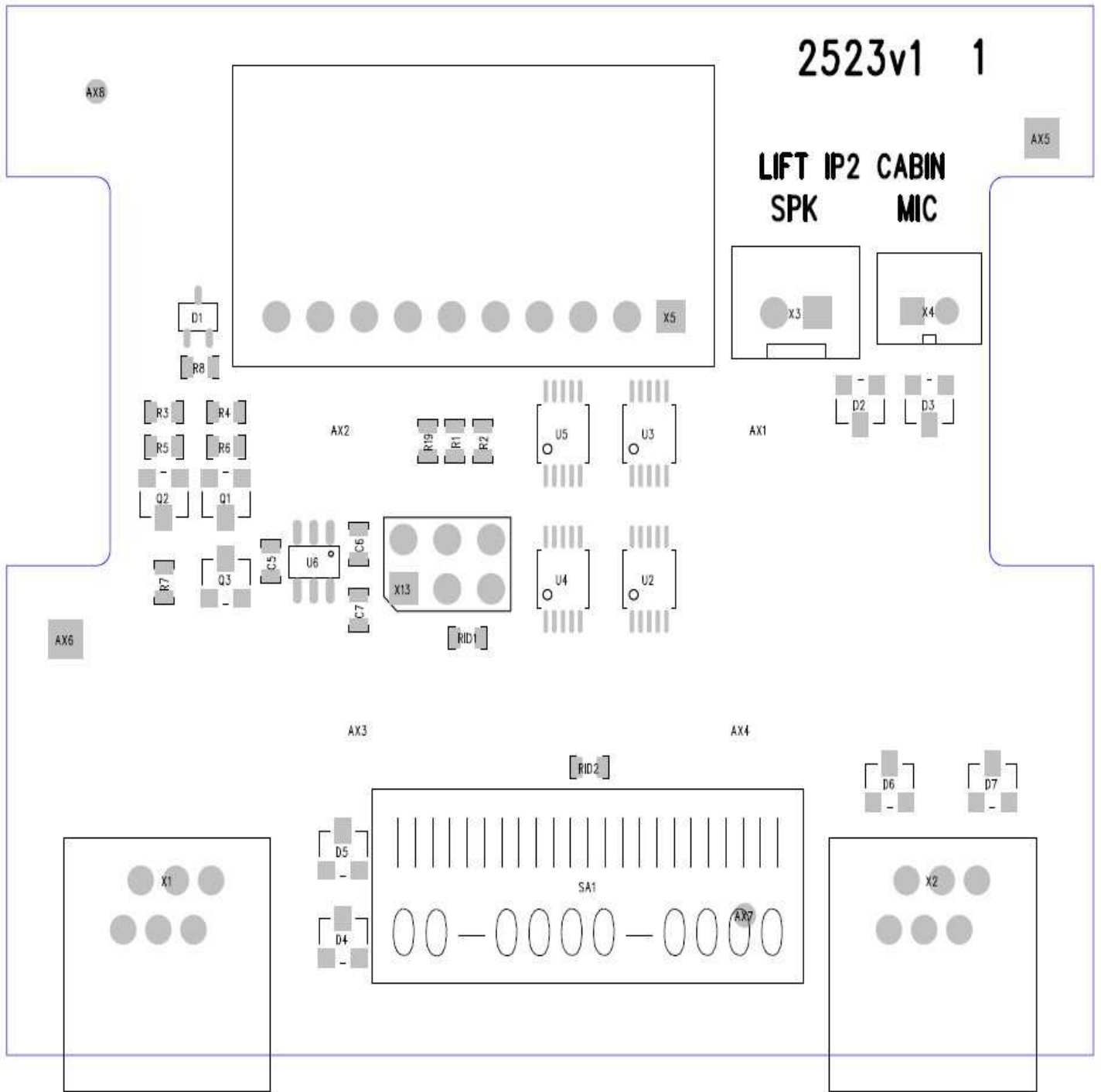

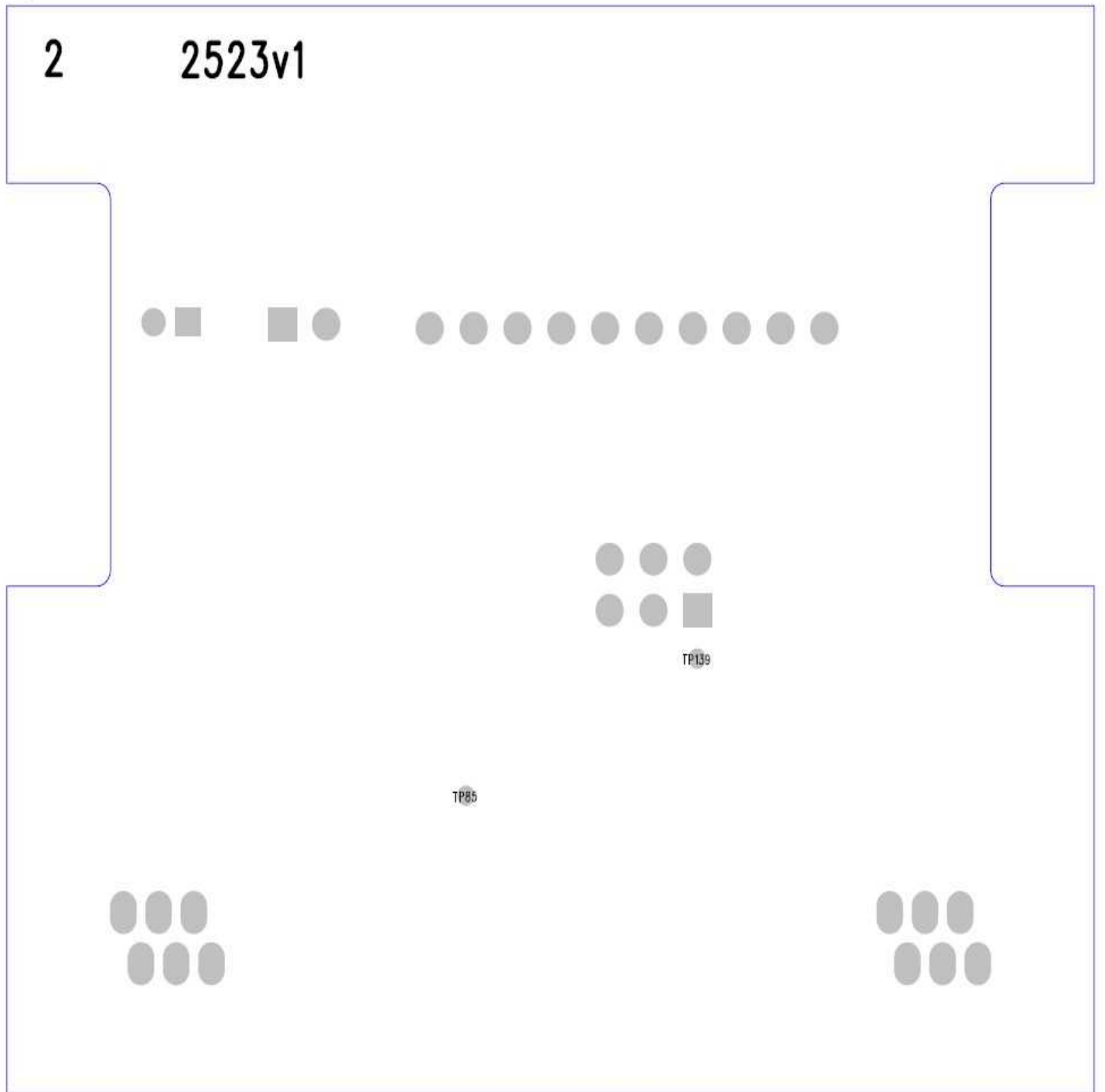

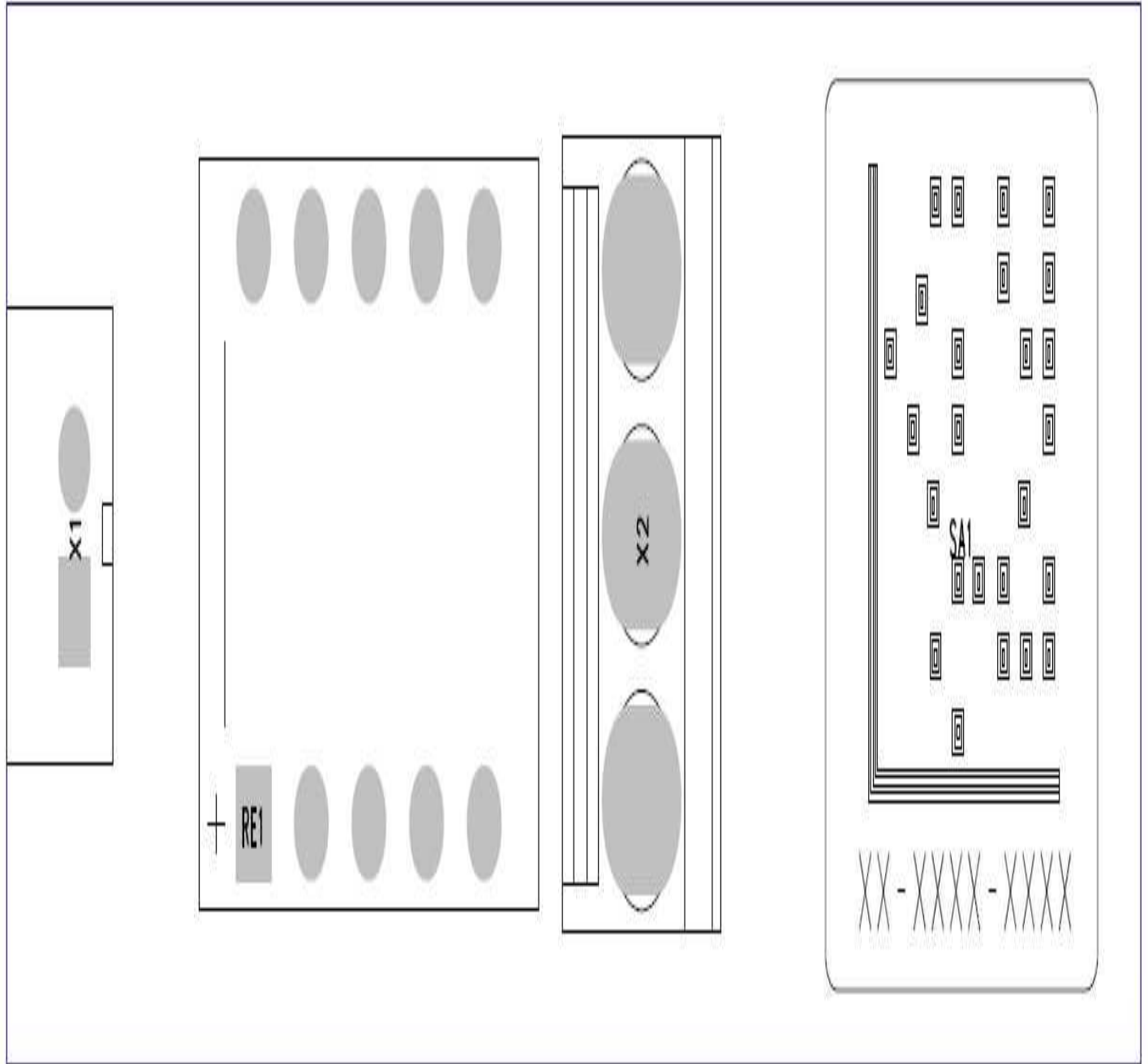

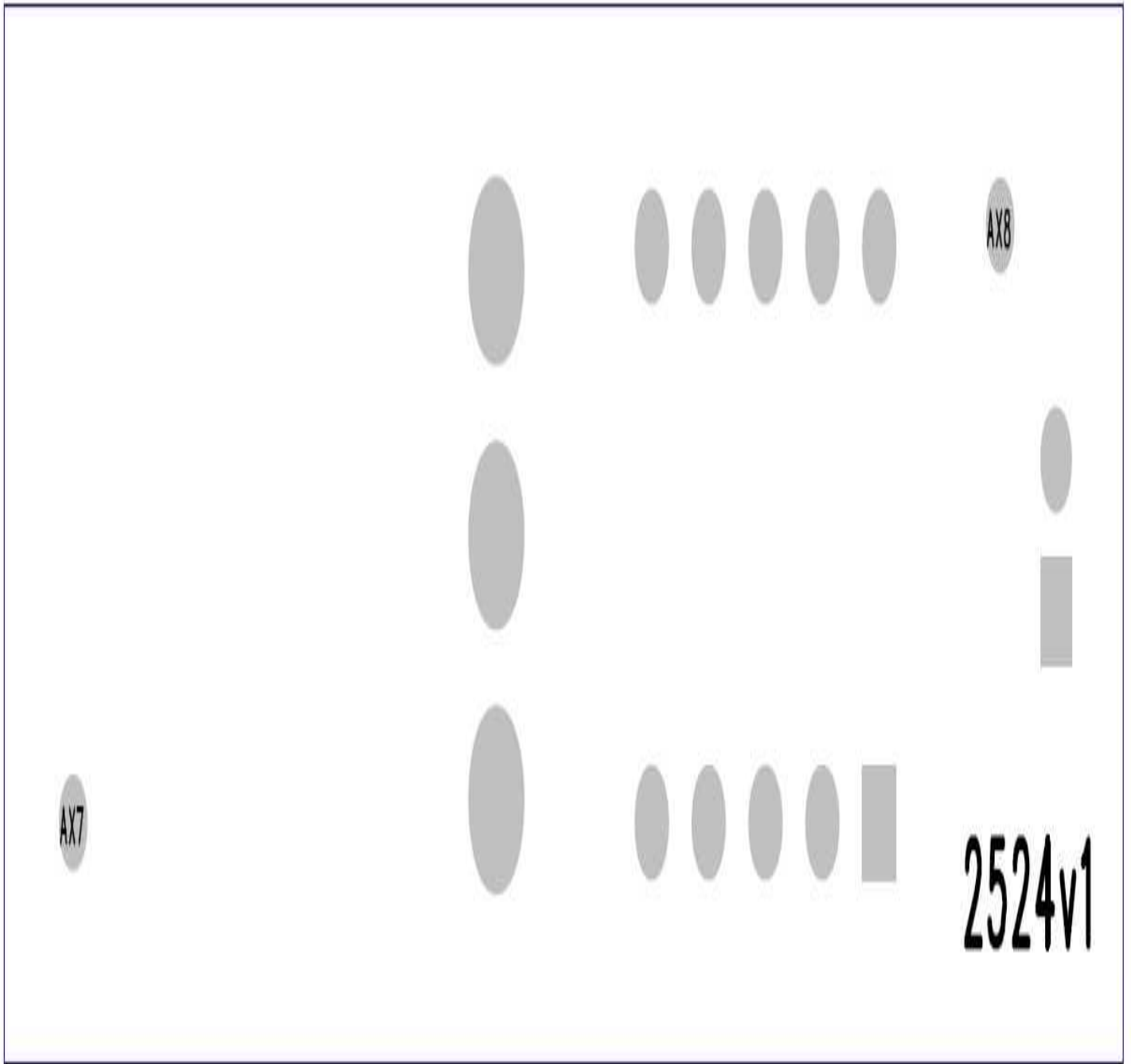

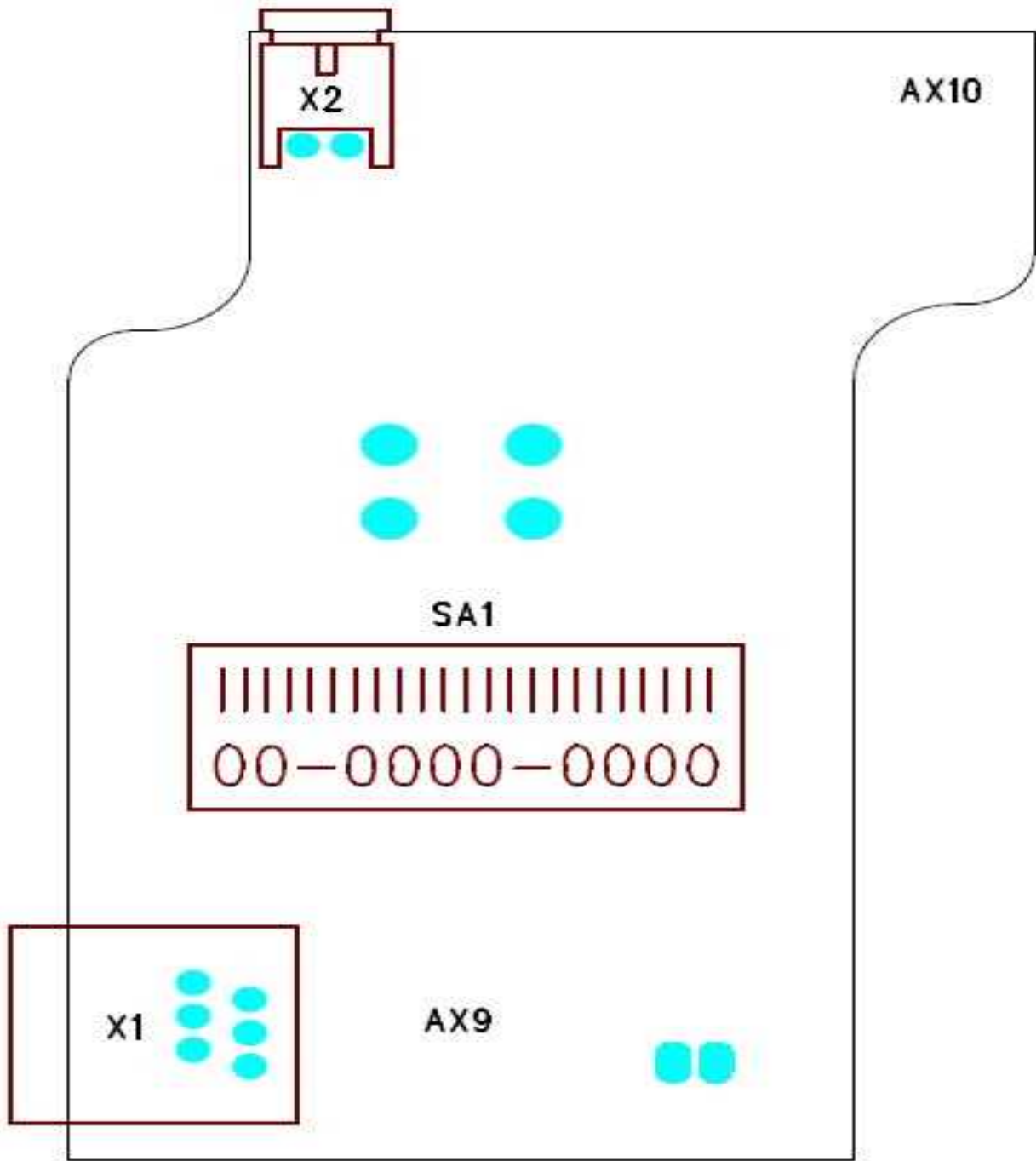

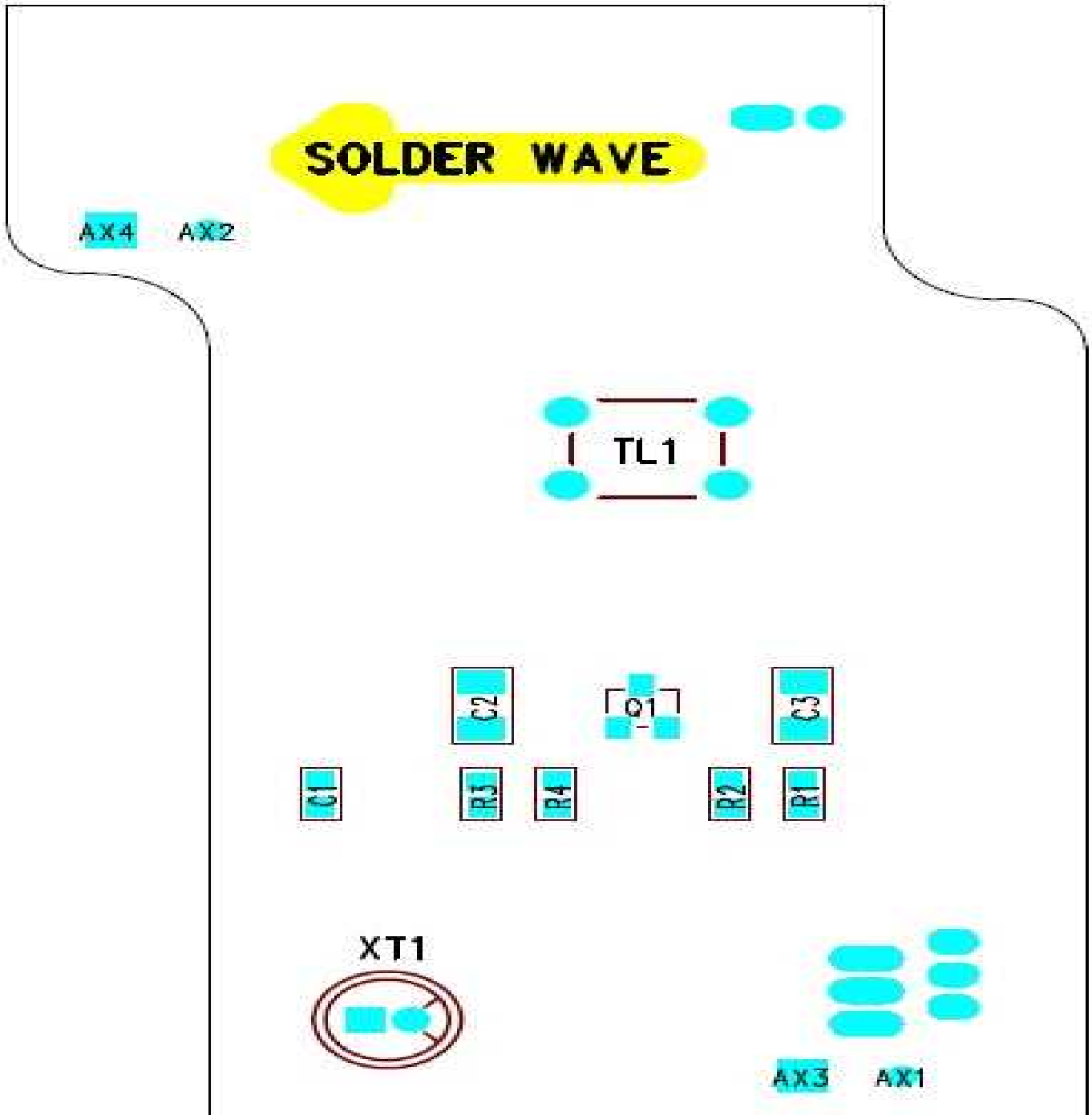

Test Record No. 1

The manufacturer submitted representative production samples of Lift communication system.

Samples #: 5348186, 5353509, 5353512 and 5353513 were used for engineering evaluation and test purposes and is considered representative of the entire series.

See Aurora database for calibrated equipment used.

The following tests were conducted:

Tests performed (name of test and test clause):	Testing location:
	UL International Polska sp. z o.o., Równoległa 4, PL-02-235 Warszawa, Poland
4.4.3.2, T.5 – STEADY FORCE TEST, 250 N	
4.4.3.4, T.6 - IMPACT TEST	
5.2.2.1-5.2.2.6 – CLASSIFICATION OF ELECTRICAL ENERGY SOURCES	
5.4.1.8 – DETERMINATION OF WORKING VOLTAGE	
5.4.10, 5.4.10.2.2 – SAFEGUARDS AGAINST TRANSIENT VOLTAGES FROM EXTERNAL CIRCUITS: IMPULSE TEST	
5.4.10, 5.4.10.2.3 – SAFEGUARDS AGAINST TRANSIENT VOLTAGES FROM EXTERNAL CIRCUITS: STEADY STATE TEST	
6.2.2.2, 6.2.2.3 – POWER MEASUREMENTS	
B.2.5 – INPUT TEST: SINGLE PHASE	
B.2.6, 5.4.1.4, 6.3, 9.3, B.1.5 – NORMAL OPERATING CONDITIONS TEMPERATURE MEASUREMENT	
B.3 – SIMULATED ABNORMAL OPERATING CONDITIONS	
B.4 – SIMULATED SINGLE FAULT CONDITIONS	
F.3.10 – TEST FOR THE PERMANENCE OF MARKINGS	
G.5.3.3 – TRANSFORMER OVERLOAD	
The following tests were waived:	Rationale for Waiving

Test results are valid only for the tested equipment. These tests are considered representative of the products covered by this Test Report. The test methods and results of the above tests have been reviewed and found to be in accordance with the requirements in the Standard(s) referenced at the beginning of this Test Report.

The following supplements are provided as part of this Test Record. NOTE: These supplements are only available to the Applicant via the myUL™ Client Portal.

Type	Supplement Id	Description
Datasheet	02-01	Datasheet